

# DU HAR VARMEPUMPEN. VI HAR TILBEHØRET!



# ENTRADE

Vi tåler sammenligning!

Entrade AS  
Semsveien 133, 1384 Asker  
Tel: 66 76 25 00. Fax: 66 76 25 01  
Mobil: 90 18 63 24 / 92 29 77 51  
E-post: morten@entrade.no  
E-post: vegard@entrade.no

[www.entrade.no](http://www.entrade.no)



**Nyhet 2014:**  
**Se side 26**

2014-2015

## Leveringsbestemmelser

Vi leverer i henhold til NL 01.

Entrade sørger for transport til leveranseadressen. Hvis kunden ønsker det sendes varen og mottaker får egen fraktfaktura fra transportøren. I motsatt fall debiterer Entrade frakten sammen med varene.

Kunden overtar ansvaret for varen når den er hentet på Entrades lager.

## Leveringstid

Alle leveranser skjer fra lager i Norge.

Hvis ordren er oss i hende før kl. 1130, sendes varen senest neste morgen.

## Priser

Prisene i katalogen er brutto-priser eksklusive moms. Verktøy er ført opp med nettopriser. Rabatt avtales med hver enkelt kunde. Prisene kan endres uten varsel.

## Bestilling

Vi foretrekker bestilling pr. E-mail. Det er også hyggelig når noen ringer.

Ved bestilling oppgi artikkelnummer og antall.

## Kontakt/Informasjon

Entrade AS  
Semsveien 133  
1384 Asker

### Kontaktpersoner:

Morten Samuelson  
Vegard Wang

Telefon: 66 76 25 00  
Telefax: 66 76 25 01  
Mobil: 90 18 63 24 (Morten)  
Mobil: 92 29 77 51 (Vegard)

Salg:  
E-post: morten@entrade.no  
E-post: vegard@entrade.no

Økonomiansvarlig:  
E-post: mette@entrade.no

# Innhold

2014  
2015

<b>1. Isolerte kobberrør</b>	2
<b>2. Kanaler og kanaldeler</b>	3
<b>3. Tilbehør til kanaler</b>	15
<b>4. Konsoller med tilbehør</b>	18
<b>5. Tetningsmasse</b>	23
<b>6. Rengjøring</b>	25
<b>7. Hus og tak for utedeler</b>	26
<b>8. Kondensvannrør og slanger</b>	27
<b>9. Kondensvannpumper</b>	30
<b>10. Varmekabel</b>	33
<b>11. Kabel</b>	34
<b>12. Strømbryter og sikkerhetsbryter</b>	36
<b>13. EI-materiell</b>	37
<b>14. Festemateriell</b>	38
<b>15. Hullsager</b>	41
<b>16. Servicemanometer og slanger</b>	43
<b>17. Nøkler og tenger</b>	46
<b>18. Bøyeverktøy, rørkutter og flareverktøy</b>	47
<b>19. Lekkagesøker og vakuummeter</b>	51
<b>20. Vakuumpumpe med tilbehør</b>	52
<b>21. Tømmeaggregat og vektor</b>	53
<b>22. Termometere, anemometer, lydnivåmåler og multimeter</b>	54
<b>23. Sveiseutstyr</b>	56
<b>24. Ventiler og nipler</b>	57
<b>25. Koblinger og flaremutter</b>	59
<b>26. Gass, kuldemedier og glykoler</b>	60
<b>27. Verneutstyr</b>	61

# Årets nyheter

2014  
2015



**Musenetting.**  
Side 17



**Digitalt manometersett.**  
Side 43



**Følg oss på Facebook**



**Digitalt manometer.**  
Side 43



**Digitalt vakuummeter.**  
Side 51



**Hus før utedel.**  
Side 26



**Tak til utedel.**  
Side 26



**Drensslange med glatt innside.** Side 27



**Drypp-panne med varme og drenering.** Side 26



**Vibrasjonsdempere for stor utedel.** Side 22



**Esterolje.**  
Side 50



**Hus for utedel**  
Side 26



**Kondensvannpumpe.**  
Side 30



**Tilslutningskabel.**  
Side 35



**Mobilvennlig løsning for netthandel kommer**



**Tømmeaggregat.**  
Side 53

## 1. Isolerte kobberør

### 1.1 Inaba



Neocoil NC

Paircoil PC

Artikkelnummer	Maksimal trykkklasse	Dim. (mm) (ytterdiam. x t)	Lengde (m)	Kveil/kartong	Pris NOK/kveil
NC-220JE	3	6.35x0.8 (1/4")	20	4	1000,00
NC-320JE	3	9.52x0.8 (3/8")	20	4	1386,00
NC-420JE	2	12.70x0.8 (1/2")	20	1	1932,00
NC-520JE	2	15.88x1.0 (5/8")	20	1	2594,00
NC-620JE	1	19.05x1.0 (3/4")	20	1	3125,00
PC-2320JE	3	6.35x0.8 (1/4")	20	2	2300,00
		9.52x0.8 (3/8")			
PC-2420JE	2	6.35x0.8 (1/4")	20	1	2785,00
		12.70x0.8 (1/2")			
PC-2520JE	2	6.35x0.8 (1/4")	20	1	3465,00
		15.88x1.0 (5/8")			
PC-3520JE	2	9.52x0.8 (3/8")	20	1	3590,00
		15.88x1.0 (5/8")			
PC-3620JE	2	9.52x0.8 (3/8")	20	1	4432,00
		19.05x1.2 (3/4")			

#### Kuldemedietrykkklasse

Klasse	Kuldemedium
Klasse 1	R407C, R404A, R507A etc.
Klasse 2	R410A, R407C, R404A, R507A etc.
Klasse 3	Kuldemedium med trykk 4.7 MPa eller høyere

\* Brannklasse D-s2, d0 (EN-13501-1)



## 2. Kanaler og kanaldeler

### 2.1 Inaba, NSD-serien

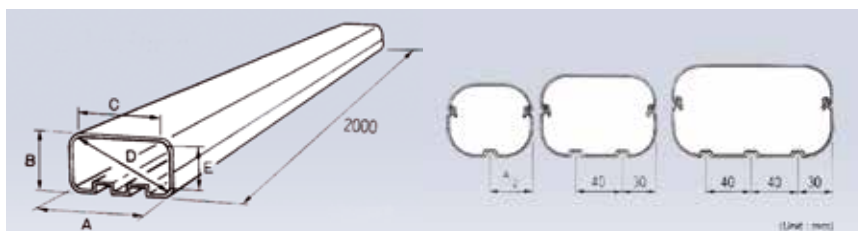

SD-kanal

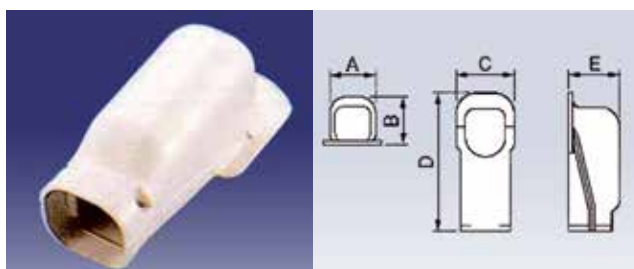

SW, veggterminal

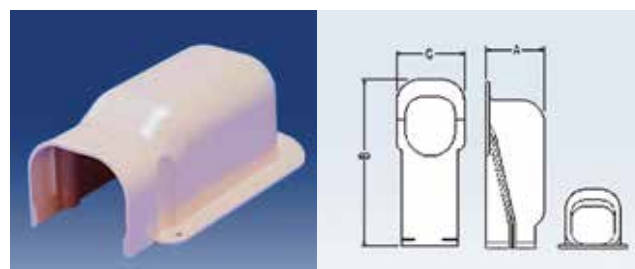

SWA, veggterminal

Artikkelnummer	A (mm)	B (mm)	C (mm)	D (mm)	E (mm)	Farge	Antall/kartong	Antall/pakke	Pris NOK/stk.
NSD-77-I	75	63	60	76	56	Beige	15	5	223,00
NSD-77-B	75	63	60	76	56	Brun	15	5	350,00
NSD-77-W	75	63	60	76	56	Hvit	15	5	223,00
NSD-100-I	100	70	86	98	63	Beige	10	5	353,00
NSD-100-B	100	70	86	98	63	Brun	10	5	505,00
NSD-100-W	100	70	86	98	63	Hvit	10	10	350,00
SWA-77-I	77	205	110	-	-	Beige	20	20	102,00
SW-77-I	83	66	110	205	77	Beige	60	10	124,00
SW-77-B	83	66	110	205	77	Brun	20	20	128,00
SW-77-W	83	66	110	205	77	Hvit	20	20	128,00
SW-100-I	110	74	128	223	86	Beige	10	10	201,00
SW-100-B	110	74	128	223	86	Brun	10	10	201,00
SW-100-W	110	74	128	223	86	Hvit	10	10	201,00

## 2. Kanaler og kanaldeler

### 2.1 Inaba, NSD-serien, forts.

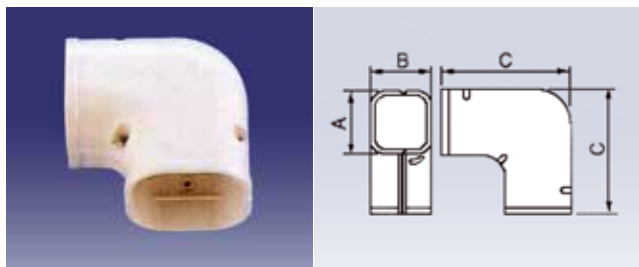

SK, flat, bend, 90 grader

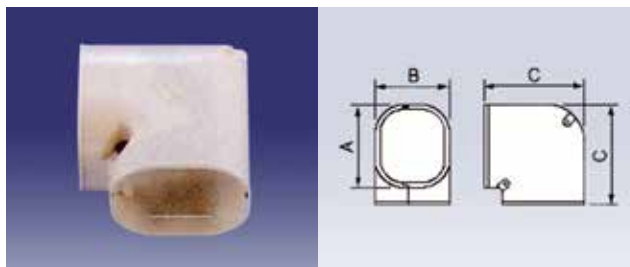

SKM, flat kort bend, 90 grader

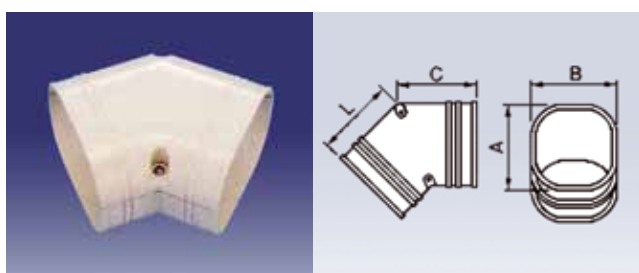

SKF, flat, bend, 45 grader

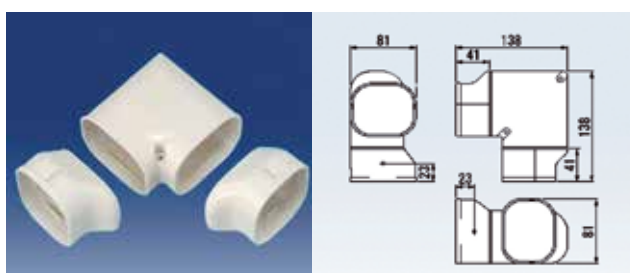

SN, flat kort vinkel, 90 grader

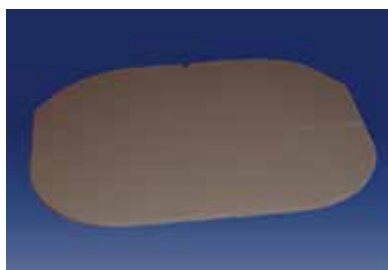

Dekkplate for kanalslutt



SDR, overgangs-muffe

Artikkel-nummer	A (mm)	B (mm)	C (mm)	Farge	Antall/kartong	Antall/pakke	Pris NOK/stk.
SK-77-I	83	66	128	Beige	60	10	122,00
SK-77-B	83	66	128	Brun	20	20	122,00
SK-77-W	83	66	128	Hvit	20	20	122,00
SK-100-I	107	74	154	Beige	10	10	199,00
SK-100-B	107	74	154	Brun	10	10	199,00
SK-100-W	107	74	154	Hvit	10	10	199,00
SKM-77-I	82	68	97	Beige	20	20	98,00
SKF-77-I	82	68	65	Beige	20	20	98,00
SKF-77-W	82	68	65	Hvit	20	20	98,00
SN-77-I	–	–	–	Beige	–	5	223,00
SAW-77-I	75	63	2	Beige	10	10	32,00
SDR-100-77-I	83	107	65	Beige	20	20	142,00

## 2. Kanaler og kanaldeler

### 2.1 Inaba, NSD-serien, forts.

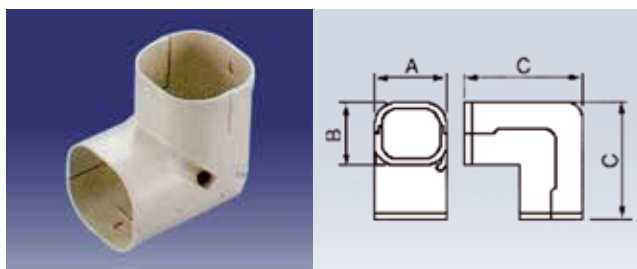

SC, albue 90 grader

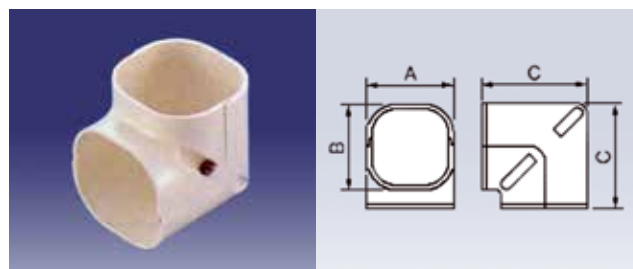

SCM, kort albue 90 grader

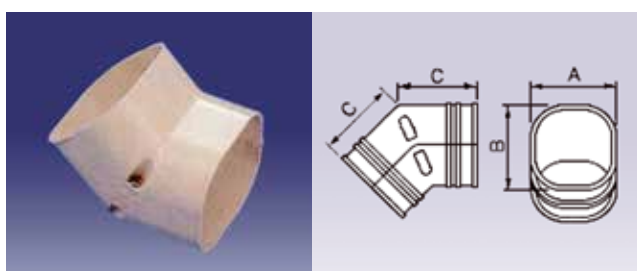

SCF, albue 45 grader

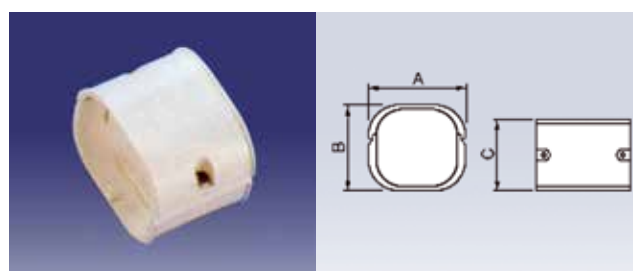

SJ, muffe

Artikkelnummer	A (mm)	B (mm)	C (mm)	Farge	Antall /kartong	Antall /pakke	Pris NOK/stk.
SC-77-I	81	67	100	Beige	20	20	122,00
SC-77-B	81	67	100	Brun	20	20	122,00
SC-77-W	81	67	100	Hvit	20	20	122,00
SC-100-I	106	75	117	Beige	10	10	199,00
SC-100-B	106	75	117	Brun	10	10	199,00
SC-100-W	106	75	117	Hvit	10	10	199,00
SCM-77-I	82	68	83	Beige	20	20	98,00
SCF-77-I	82	68	61	Beige	20	20	98,00
SCF-77-W	82	68	61	Hvit	20	20	98,00
SJ-77-I	85	67	50	Beige	20	20	37,00
SJ-77-B	85	67	50	Brun	20	20	40,00
SJ-77-W	85	67	50	Hvit	20	20	40,00
SJ-100-I	109	75	66	Beige	20	20	74,00
SJ-100-B	109	75	66	Brun	20	20	74,00
SJ-100-W	109	75	66	Hvit	20	20	74,00

## 2. Kanaler og kanaldeler

### 2.1 Inaba, NSD-serien, forts.

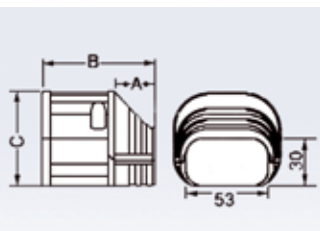

SE, endeavslutning  
SEN

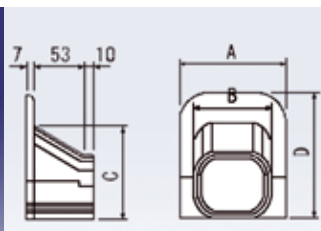

SP, overgang til tak

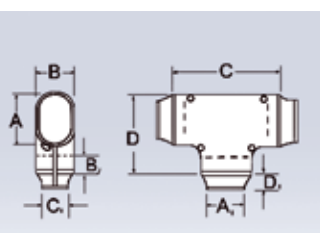

ST, T med overgangsmuffe 2 st SDR

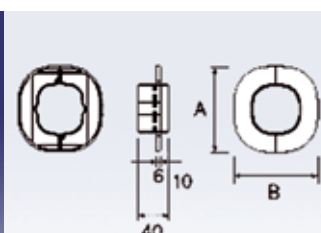

SWC, dekklokk vid vegg, hull – 85 mm

Artikkelnummer	A (mm)	B (mm)	C (mm)	D (mm)	E (mm)	Farge	Antall/pakke	Pris NOK/stk.
SE-77-I	45	82	67	–	–	Beige	20	66,00
SE-77-B	45	82	67	–	–	Brun	20	66,00
SE-77-W	45	82	67	–	–	Hvit	20	66,00
SEN-100-I	56	112	76	–	–	Beige	20	122,00
SEN-100-B	56	112	76	–	–	Brun	20	122,00
SEN-100-W	56	112	76	–	–	Hvit	20	122,00
SP-77-I	110	81	100	130	–	Beige	20	145,00
SP-77-B	110	81	100	130	–	Brun	20	150,00
SP-77-W	110	81	100	130	–	Hvit	20	150,00
ST-77-I	85	68	165	124	31	Beige	10	283,00
ST-77-W	85	68	165	124	31	Hvit	10	283,00
ST-100-I	109	78	200	154	33	Beige	10	399,00
ST-100-B	109	78	200	154	33	Brun	10	399,00
ST-100-W	109	78	200	154	33	Hvit	10	189,00
SWC-77-I	127	115	–	–	–	Beige	100 (10)	49,00
SWC-77-B	127	115	–	–	–	Brun	100 (10)	49,00
SWC-77-W	127	115	–	–	–	Hvit	100 (10)	49,00
SWC-100-I	174	144	–	–	–	Beige	50 (10)	69,00
SWC-100-B	174	144	–	–	–	Brun	50 (10)	69,00



## 2. Kanaler og kanaldeler

### 2.2 Inaba, NSD-serien, forts.



SFS, klammer for flexibel overgang SF

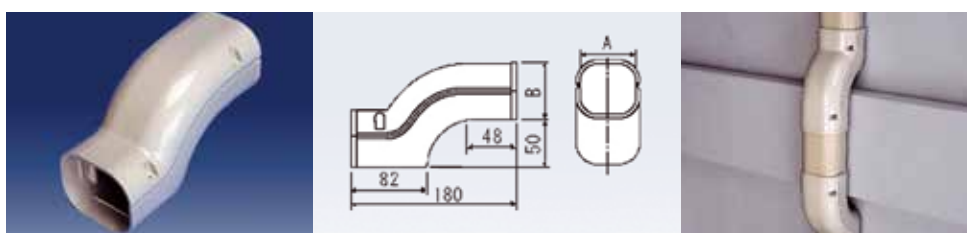

SIF, fast overgang



SF, flexibel kanal

Artikkel-nummer	A (mm)	B (mm)	C (mm)	D (mm)	Farge	Antall/pakke	Pris NOK/stk.
SF-77-500-I	72	74	62	495	Beige	20	103,00
SF-77-500-B	72	74	62	495	Brun	20	103,00
SF-77-500-W	72	74	62	495	Hvit	20	103,00
SF-77-1000-I	72	74	62	1033	Beige	20	172,00
SF-100-800-I	70	100	70	800	Beige	10	197,00
SF-100-800-W	70	100	70	800	Hvit	10	197,00
SFS-77	75	63	18	–	–	60	81,00
SIF-77-I	69	83	–	–	Beige	10	155,00
SIF-77-B	69	83	–	–	Brun	10	155,00
SIF-77-W	69	83	–	–	Hvit	10	155,00
SIF-100-B	74	108	–	–	Brun	10	290,00

## 2. Kanaler og kanaldeler

### 2.3 QsanTec, QD-serien



Rett kanal QD-8, Hvit



Veggterminal QW-8, Hvit



Flatt bend QP-8, Hvit



Rett kanal QD-8, Brun



Veggterminal QW-8, Brun



Flatt bend QP-8, Brun



Rett kanal QD-8, Rød



Veggterminal QW-8, Rød



Flatt bend QP-8, Rød

Artikkel-nummer	Beskrivelse	(mm)	Farge	Fargekode (RAL)	Antall i pakke	Pris NOK/stk.
QD-8-W	Rett kanal QW	80	Hvit	9010	8	168,00
QD-8-B	Rett kanal QB	80	Brun	8016	8	168,00
QD-8-R	Rett kanal QR	80	Rød	3011	8	168,00
QW-8-W	Veggterminal QW	80	Hvit	9010	36	68,00
QW-8-B	Veggterminal QW	80	Brun	8016	36	68,00
QW-8-R	Veggterminal QW	80	Rød	3011	36	68,00
QP-8-W	Flatt bend QP	80	Hvit	9010	42	68,00
QP-8-B	Flatt bend QP	80	Brun	8016	42	68,00
QP-8-R	Flatt bend QP	80	Rød	3011	42	68,00

## 2. Kanaler og kanaldeler

### 2.3 QsanTec, QD-serien, forts.



Albue QC-8, Hvit



Muffe QJ-8, Hvit



Endeavslutning QE-8, Hvit



Albue QC-8, Brun



Muffe QJ-8, Brun

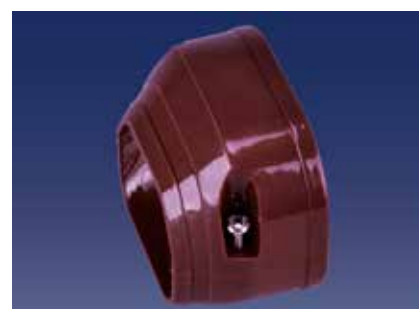

Endeavslutning QE-8, Brun



Albue QC-8, Rød



Muffe QJ-8, Rød



Endeavslutning QE-8, Rød

Artikkelnummer	Beskrivelse	(mm)	Farge	Fargekode (RAL)	Antall i pakke	Pris NOK/stk.
QC-8-W	Albue	80	Hvit	9010	72	68,00
QC-8-B	Albue	80	Brun	8016	72	68,00
QC-8-R	Albue	80	Rød	3011	72	68,00
QJ-8-W	Muffe	80	Hvit	9010	168	32,00
QJ-8-B	Muffe	80	Brun	8016	168	32,00
QJ-8-R	Muffe	80	Rød	3011	168	32,00
QE-8-W	Endeavslutning	80	Hvit	9010	264	42,00
QE-8-B	Endeavslutning	80	Brun	8016	264	42,00
QE-8-R	Endeavslutning	80	Rød	3011	264	42,00

## 2. Kanaler och kanaldelar

### 2.4 QsanTec, KD-serien



KD-8-W



KW-8-W



KWA-8-W

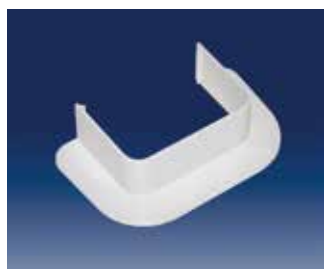

KC-8-W

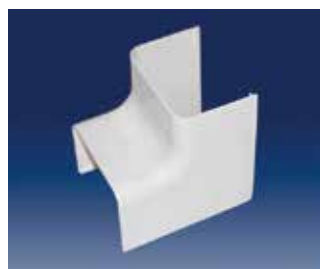

KI-8-W



KY-8-W

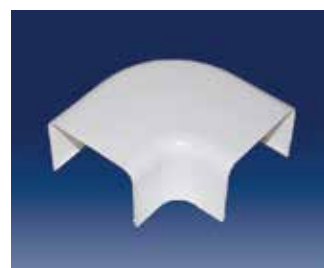

KP-8-W



KJ-8-W

Artikkel-nummer	Benevning	Bredde (mm)	Dybde (mm)	Farge	Antall i kartong	Pris NOK/stk.
KD-8-W	Rett kanal, 2 meter	77	54	Hvit	6	150,00
KW-8-W	Veggterminal	77	54	Hvit	10	58,00
KWA-8-W	Avslutning	77	54	Hvit	10	58,00
KC-8-W	Veggrosett	77	54	Hvit	10	54,00
KI-8-W	Innvendig hjørne	77	54	Hvit	10	54,00
KY-8-W	Utvendig hjørne	77	54	Hvit	10	48,00
KP-8-W	Rett vinkel 90°	77	54	Hvit	10	64,00
KJ-8-W	Muffe	77	54	Hvit	10	26,00

## 2. Kanaler og kanaldeler

### 2.5 Artiplastic



Rørkanal BC

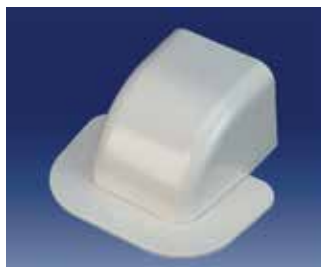

Veggterminal CM

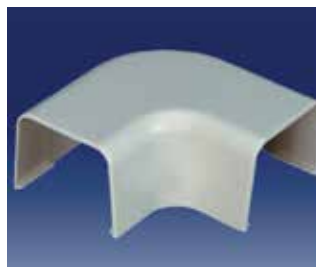

Vertikalt hjørne CP

Artikkel-nummer	Bredde (mm)	Dybde (mm)	Antall/pakke	Pris NOK/stk.
-----------------	-------------	------------	--------------	---------------

#### KANALER BC

BC30	25	25	32 (64 m)	52,00
BC70	70	55	12 (24 m)	156,00
BC80	80	60	8 (16 m)	189,00
BC120	110	75	4 (8 m)	278,00
BC140	140	90	4 (8 m)	423,00

#### VEGGTERMINAL CM

CM70	70	55	9	75,00
CM80	80	60	6	92,00
CM120	110	75	4	116,00
CM140	140	90	4	163,00

#### VERTIKALT HJØRNE CP

CP30	25	25	20	18,00
CP70	70	55	10	62,00
CP80	80	60	8	81,00
CP120	110	75	6	106,00
CP140	140	90	6	148,00



## 2. Kanaler og kanaldeler

### 2.5 Artiastic, forts.

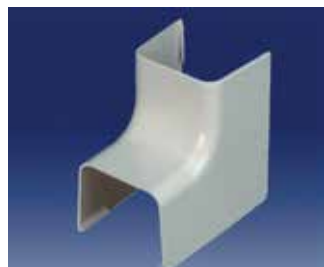

Innvendig hjørne AI

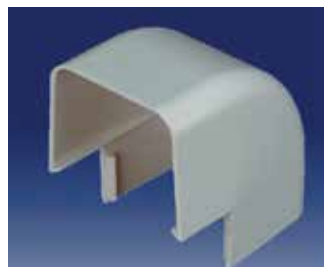

Utvendig hjørne AE

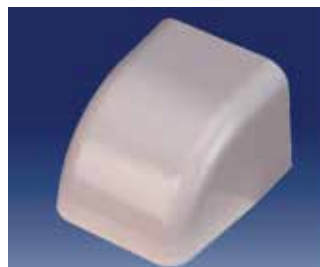

Avslutning TT

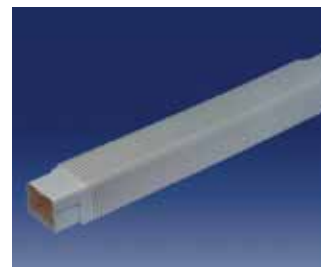

Fleksibel kanaldel GF

Artikkel-nummer	Bredde (mm)	Dybde (mm)	Antall/pakke	Pris NOK/stk.
-----------------	-------------	------------	--------------	---------------

#### INNVEDIG HJØRNE AI

AI30	25	25	20	20,00
AI70	70	55	8	55,00
AI80	80	60	6	59,00
AI120	110	75	4	75,00
AI140	140	90	4	98,00

#### UTVENDIG HJØRNE AE

AE30	25	25	20	20,00
AE70	70	55	12	55,00
AE80	80	60	9	59,00
AE120	110	75	6	75,00
AE140	140	90	6	98,00

#### AVSLUTNING TT

TT30	25	25	20	19,00
TT70	70	55	12	50,00
TT80	80	60	9	57,00

#### FLEKSIBEL KANALDEL GF

GF80	80	60	4	127,00
------	----	----	---	--------

## 2. Kanaler og kanaldeler

### 2.5 Artiplastic, forts.

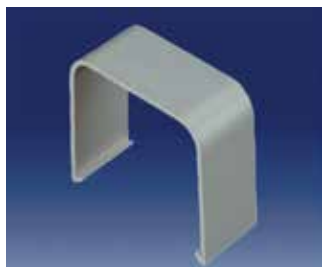

Muffe GC

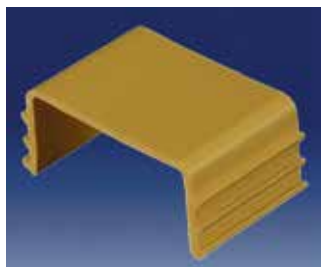

Festeklammer ST

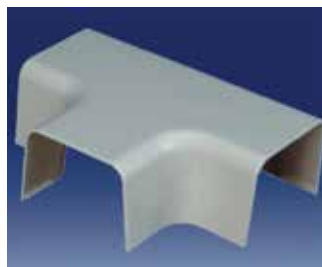

T-stykke DT

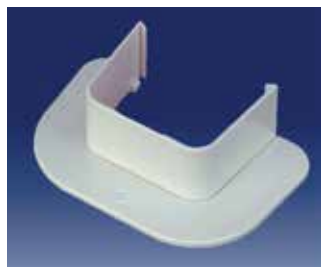

Flens PM

Artikkel-nummer	Bredde (mm)	Dybde (mm)	Antall/pakke	Pris NOK/stk.
-----------------	-------------	------------	--------------	---------------

#### SKJØTEMUFFE GC

GC30	25	25	20	20,00
GC70	70	55	30	32,00
GC80	80	60	30	36,00
GC120	110	75	20	42,00
GC140	140	90	20	54,00

#### FESTEKLAMMER ST

ST70	70	55	30	9,00
ST80	80	60	30	9,00
ST120	110	75	20	11,00
ST140	140	90	20	13,00

#### T-STYKKE DT

DT80	80	60	4	141,00
DT120	110	75	2	176,00
DT140	140	90	2	248,00

#### DEKK-LOKK PM

PM70	70	55	10	59,00
PM80	80	60	8	71,00
PM120	110	75	8	96,00
PM140	140	90	8	145,00

## 2. Kanaler og kanaldeler

### 2.5 Artiastic, forts.

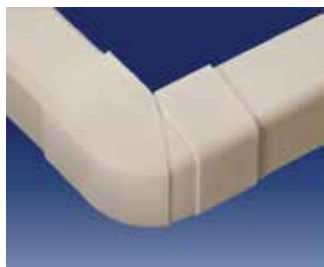

Utv. justerb. hjørne ER



Inv. justerbart hjørne IR



Vert. justerb. hjørne PR



Vinkel 90° vridd høyre VD



Reduksjon RI



Kanalborring RC



Vridd hjørne VS80

Artikkelnummer	Bredde (mm)	Dybde (mm)	Antall/pakke	Pris NOK/stk.
----------------	-------------	------------	--------------	---------------

#### JUSTERBARE HJØRNER

ER80	80	60	6	68,00
IR80	80	60	4	68,00
PR80	80	60	6	92,00

#### REDUKSJONER

RI1280	80-110	60-75	8	48,00
RI1412	110-140	75-90	8	87,00

#### KANALANBORRING RC

RC30	25	25	20	19,00
------	----	----	----	-------

#### VRIDD HJØRNE

VD80	80	60	4	143,00
VS80	80	60	4	143,00

### 3. Tilbehør til kanaler

#### 3.1 Tape



DHF. Isolert tape

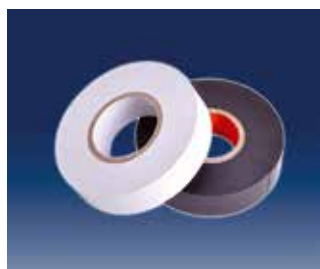

PVC-tape. Eltape



ITS-503. Isolertape, svart

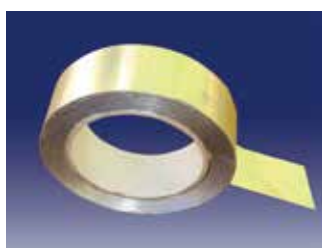
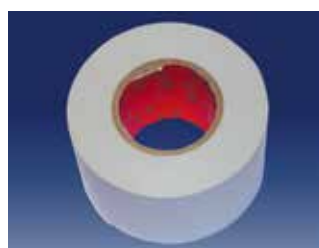

ITSA-503.

ALT-3550. Alu.tape  
uten dekkpapirALT-5050. Alu.tape  
med dekkpapirNAT-5050. PVC-bånd  
uten klister

ITV-503. Isolertape, hvit

Artikkelnummer	Farge	Dimensjon (mm) Lengde x bredde x dybde	Beskrivelse	Antall/ pakke	Pris NOK/stk.
DHF-50	Grå	3 m x 50 mm x 4 mm	Isolertape	60	190,00
ITS-503	Svart	9,14 m x 50 mm x 3 mm	Isolertape	30	108,00
ITSA-503	Svart	9,14 m x 50 mm x 3 mm	Isolertape/Armert	30	214,00
ITV-503	Hvit	9,14 m x 50 mm x 3 mm	Isolertape, PE	30	108,00
ALT-3550	Sølv	50 m x 35 mm x 40 µ	Uten dekkpapir	30	105,00
ALT-5050	Sølv	50 m x 50 mm x 60 µ	Med dekkpapir	24	164,00
PTV-1920	Hvit	20 m x 19 mm x 0,2 mm	Eltape	10	16,00
PTS-1920	Svart	20 m x 19 mm x 0,2 mm	Eltape	10	16,00
PTV-4812	Hvit	12 m x 48 mm x 0,2 mm	Eltape	5	21,00
PTV-4820	Hvit	20 m x 48 mm x 0,2 mm	Eltape	5	32,00
NAT-5050	Hvit	50 m x 50 mm x 0,2 mm	Bånd uten klister	5	63,00

### 3. Tilbehør til kanaler

#### 3.2 Strips og holdere

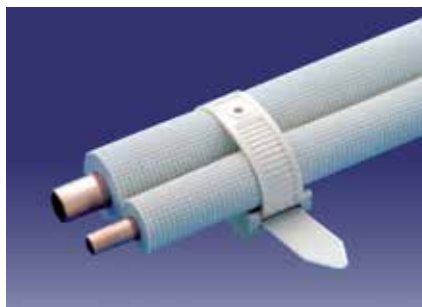

Modell BT



Strips i pakker

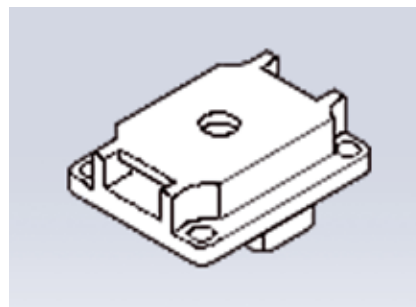

Modell BHC-1 BHC-1 for BT



Strips modell ETS

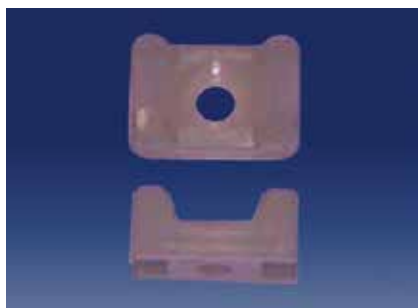

Stripsholdere ETS2 for ETS



Strips med holder. SL-300



Stripsholdere ETS410

Artikkel-nummer	L (mm)	A (mm)	H (mm)	t (mm)	Bindings-diameter (mm)	Pakke/kartong	Antall/pakke	Pris NOK/pakke
BT-300	300	90	10	2,5	82	20	20	256,00
BHC-1	64	52,5	–	–	25-65	100	1	36,00
ETS 200	200	4,8	5	1,5	55	100	100	58,00
ETS 300	300	4,8	5	1,5	80	100	100	90,00
ETS 2	15	9	7	4	–	100	100	47,00
ETS410	22	16	10	5	–	–	100	404,00
SL-300	300	8	7	2	82	50	10	84,00



### 3. Tilbehør til kanaler

#### 3.3 Trolleflex gjennomføringer

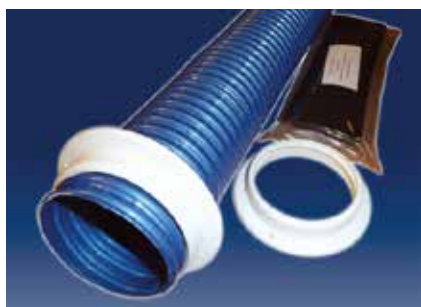

Trolleflex kit

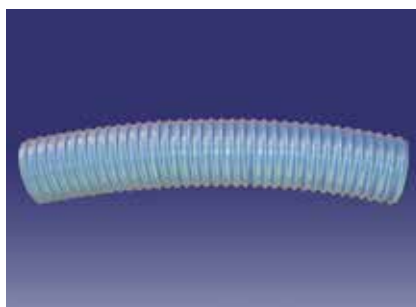

Trolleflex rør

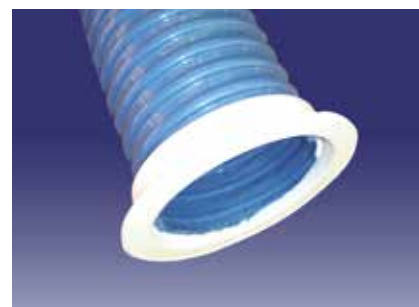

Trolleflex mutter



Trolleflex skum

Castel Justerbart rør med flens  
TRV-350Beskyttelsesnett mot mus i vegg  
TRS2520

#### Trolleflex

Artikkelnummer	Beskrivelse	Diameter (mm)*	Lengde (mm)	Pris NOK/stk.
TRF-KIT	Trolleflex Kit, 1 st rør + 2 muttere + 1 st miljøskum	63	350	311,00
TRF-R63-350	Trolleflex rør	63	350	108,00
TRF-R63-800	Trolleflex rør	63	800	399,00
TRF-R63-1000	Trolleflex rør	63	1000	491,00
TRF-M63	Trolleflex mutter	63	–	36,00
TRF-SK	Trolleflex skum	–	–	51,00
TRS-2520	Beskyttelsesnett mot mus i vegg	B = 200	250	30,00

\* Hullet i vegg skal bores med diameter 73 mm.

#### Castel

Artikkelnummer	Beskrivelse	Diameter (mm)**	Lengde (mm)	Pris NOK/stk.
TRV-350	Justerbart rør med flens	100x60	350	108,00

\*\* Hullet i vegg skal bores med diameter 64 mm.

## 4. Konsoller med tilbehør

### 4.1 Konsoller



HB-480



HB-550



HBF-480



HBB-480



GC-50



GC-55



GCG-51



GC-90

Konsollene er galvanisert og pulverlakkert.  
Alle konsoller leveres med festebolter.

Artikkel- nummer	Maksimal belastn. (kg)	Lengde	Dimensjon (mm)		Dybde	Info	Antall/ pakke	Pris NOK/stk.
			Høyde	Bredde				
HB-480	80	800	420	200-700	480	Med skinne	6	318,00
HB-550	150	900	420	200-800	550	Med skinne	6	352,00
HBF-480	100	800	380	200-700	480	Med skinne	6	325,00
HBB-480	80	–	420	–	480	Separate	6	283,00
GC-50	50	–	230	–	500	Vendbar	6	257,00
GC-55	80	–	270	–	550	Separate	6	278,00
GCG-51*	50	–	230	–	500	Vendbar	6	268,00
GC-90	50	–	270	–	900	Separate	4	325,00

\* Varmgalvanisert, ikke pulverlakkert.

## 4. Konsoller med tilbehør

### 4.2 Markkonsoller/bakkestativ



GB-47



GB-48



GB-58



GB-68



GB-58S



GB-68S



GB-69S



GB-88S



GB-51/GB-60

Konsollene er galvanisert og pulverlakkert.  
Alle konsoller leveres med festebolter. Farge: Grå.

Artikkelnummer	Maksimal belastning (kg)	Lengde	Dimensjon (mm)		Antall/pakke	Pris NOK/stk.
			Bredde	Høyde		
GB-47	100	800	380	150-200	3	545,00
GB-48	100	850	380	350-400	3	567,00
GB-51	100	530-650	420	440-500	3	545,00
GB-58	100	850	430	350-400	3	565,00
GB-60*	100	450-650	420	640-700	3	577,00
GB-68	100	850	430	550-600	3	667,00
GB-58S	160	850	430	350-400	2	667,00
GB-68S	160	850	430	550-600	2	706,00
GB-69S	160	850	580	550-600	2	773,00
GB-88S	160	850	430	800-850	2	876,00

\* Leveres med platefot. Gummifot kan kjøpes separat  
Artikkel AGA5520

## 4. Konsoller med tilbehør

### 4.3 Sockelkonsoller og takkonsoller



BB-480



BBL-480



HBR-480 For yttertak



BBH-450/BBH-480



BBA-480



BR-480 For undertak

Konsollene er galvanisert og pulverlakkert.  
Alle konsoller leveres med festbolter. Farge: Grå.

Artikkel- nummer	Maksimal belastn. (kg)	Lengde	Dimensjon (mm)			Info	Antall/ pakke	Pris NOK/stk.
			Høyde	Breidd	Dybde			
BB-480	50	–	300+200	–	480	Separate	6	388,00
BBL-480	–	–	370-630	–	–	Ben til BB-480 og BBH-480	6	142,00
BBH-480	150	800	350+250	200-700	480	Med skinne	3	499,00
BBH-450	150	800	350-124	200-700	450	Med skinne og justerings-skruer	3	504,00
BBA-480	80	800	124	200-700	480	Med skinne og justerings-skruer	6	284,00
HBR-480	100	800	500	550-700	480	For yttertak	4	452,00
BR-480	80	–	750	–	480	For undertak	3	515,00

## 4. Konsoller med tilbehør

### 4.4 Montasjeblokker



PR. Montageblock



PR-P2. Festebrakett

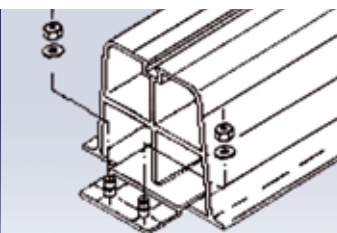

Endeplate for PR-351



PR-350W

Artikkelnummer	Farge	Maks. belastn. per st (kg)	Dimensjon (D) L x H (mm)	Info	Antall/pakke	Pris NOK/stk.
PR-351N-I	Beige	140	350 x 95		20	97,00
PR-351N-M	Beige	140	450 x 95		20	125,00
PR-350W	Hvit	200	350 x 100		12	83,00
PRC-351N	Beige	–	–	Til PR-351	50	87,00
PR-P2	–	–	80 x 60 x 2,0		100	110,00



## 4. Konsoller med tilbehør

### 4.5 Vibrasjonsdempere



ANA 3025, ANA 3025-40  
AA 3025-40



ANA 4040



AA 4030-40



AA 3343-40



AGA5520  
Passar till GB-60



ANC 3030  
AC 3030-40



ACA 4225-40



AA 5030-40



Fjæderdämpare AFA770



Skiva GBW 20



Skiva GBW0 25



Skiva GBW25

Artikkel-nummer	Farge	Maks. belastn. per st (kg)	Dimensjon (D) L x H (mm)	Info	Antal/pakke	Pris NOK/stk.
ANA3025-40	Svart	10-15	30 x 25	Myk	50	68,00
AA3025-40	Svart	10-15	30 x 25	Myk	50	120,00
ANA4040	Svart	20-35	40 x 40	Myk	40	100,00
AA4030-40	Svart	20-35	40 x 30	Myk	30	160,00
AA5030-40	Svart	75	50 x 30	Myk M10	20	370,00
AA3343-40	Svart	20-35	30-40 x 30	Myk	40	140,00
ANC3030	Svart	10-15	30 x 30	Fast	50	68,00
ACA4225-40	Grå	10-15	40-30 x 23	Myk, konisk	50	68,00
AGA5520	Svart	20-35	55 x 20	Fast, for plasser. på bakken		99,00
AFA770	Sølv	20-30	45 x 60	Fjær	1	299,00
GBW20	Sølv	–	20 x 1,2	Rund skive	500	167,00
GBW025	Sølv	–	25 x 2,0	Åpen skive	250	190,00

Vibrasjonsdempere leveres i poser av 4 stk. med mutter skiver eller bolter.  
Harheten på myke er 40 Shore. På harde 60 Shore.

## 5. Tetningsmasse



Bygg og våtromssilikon, Hvit



Fugeskum



Pistolskum



Skumfjerner

Artikkelnummer	Beskrivelse	Volym (ml)	Anmerkning	Antall/pakke	Pris NOK/stk.
TR-501911	Bygg- og våtromssilikon	300	Klass 25 LM. Nøytralt herdesystem. Hvit Max. temp.: 100°C	12	95,00
TR-701280	Fugeskum	500	1-komponent polyuretan, hurtigherdende	12	95,00
TR-701281	Fugeskum	750	1-komponent polyuretan, hurtigherdende	12	122,00
TR-701528	Pistolskum	750	Som fugeskum, men beregnet for skumpistol.	12	374,00
TR-325693	Skumfjerner	500	Rengjør fugeskum og skumpistol.	12	110,00

## 5. Tetningsmasse, forts.



Latex/akryl



Utefuge

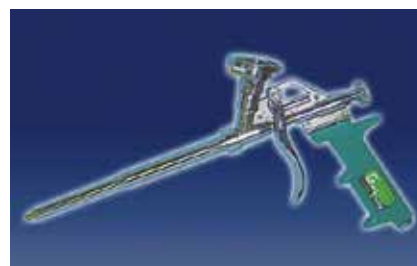

Skumpistol, standard



Håndsprøyte, PTR



Håndsprøyte, skjelett



Skumpistol Basic

Artikkelnummer	Beskrivelse	Volum (ml)	Info	Antall/pakke	Pris NOK/stk.
TR-701370	Latex/akryl	300	Klasse 12.5 E OBS, ikke frostfri. Myk for inne og ute. Hvit.	12	47,00
TR-701638	Utendørs fuge	300	Klasse 12.5 P Frostfri. Oljebasert fugemasse. Hvit.	12	47,00
TR-702808	Håndsprøyte, PTR	–	For 300 ml tub.	1	343,00
TR-701346	Håndsprøyte, skjelett	–	For 300 ml tub.	1	77,00
TR-703135	Skumpistol, standard	–	For Pistolskum	1	284,00
TR-703136	Skumpistol Basic	–	For Pistolskum	1	125,00

## 6. Rengjøring

**FRIONETT fjerner bakterier, virus og alger i klimaanlegg.**



**1.** Demonter filtre, støvsug og benytt Frionett Activ RTU eller FRionett Activ Foam.



**2.** Sprut så på og mellom lamellene.



**3.** Etter tørking spray Frionett Activ Shot på tilluftsiden av lamellene. Middelet dreper bakterier, sopp og virus. Gir også frisk luft.

**Frionett fungerer i overensstemmelse med følgende Europeiske standarder:**

Bakterier: EN 1040  
Legionelle: T72300-301  
Salmonella: T72300-301  
Sopp : EN 1275  
Virus: 72180



FRIONETT Activ RTU



FRIONETT Activ Dunk



FRIONETT Activ Foam



FRIONETT Activ One Shot



FRIONETT Power RTU



FRIONETT Power Dunk



Rengjøringsduk



Sitrusvask

**Frionett Power** er en effektiv fettløser men har ikke bakteriedrepende effekt.

Artikkelnummer	Beskrivelse	Volum	Antall/pakke	Pris NOK/stk.
CL8007383	Frionett Activ RTU	0,75 liter	12	286,00
CL8007384	Frionett Activ Dunk	5,0 liter	4	906,00
CL8007382	Frionett Activ Foam	500 ml.	12	335,00
CL8007381	Frionett Activ One Shot	150 ml.	12	112,00
CL8007379	Frionett Power RTU	0,75 liter	12	218,00
CL8007380	Frionett Power Dunk	5,0 liter	4	719,00
CL42230	Rengjøringsduk Scrubs	30 duker i spann	6	260,00
Sitrusvask	Rengjøringsmiddel	1 liter	12	168,00

## 7. Hus og tak for utedeler

2014  
2015



Hus for utedel,  
VPS01/VPS02/VPS03



Tak til utedel, HAR01

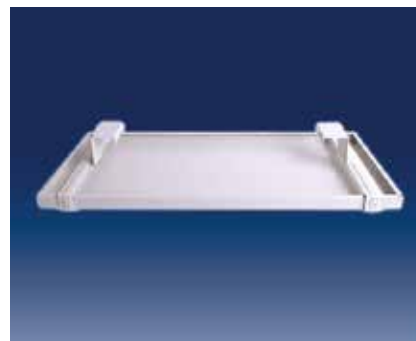

Drypp-panne,  
HADT01/HADT02



Drypp-panne med varme-  
kabel. Svenskprodusert  
HADT91

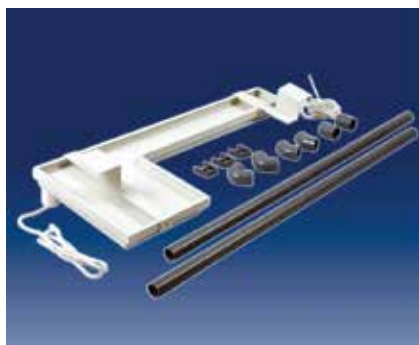

Drypp-panne med varme, HADT97/98.



Hus for utedel i metall, meget enkel  
montering, VPS-90

**Sikkerhetswire benyttes når utedel står på markstativ. Skrues fast i utedel og husvegg.**

Artikkel- nummer	Innvendige mål			Vekt (kg)	Beskrivelse	Pris NOK/pak.
	Lengde (mm)	Høyde (mm)	Dybde (mm)			
VPS01	920	635-690	410	15		2095,00
VPS02	1060	890-945	405	20		2774,00
HAR01	920	200	540	3	Med distanser t. vegg	550,00
HADT01	820	20	340	3		610,00
HADT02	1000	20	410	4		665,00
HADT91	780	120	330	1	Varmekabel med termostat P=75W Produsert i plast	2295,00
HADT97	820/250	20 + 20	340/100	2	Integrert varmekabel med termostat. P=60W	1500,00
HADT98	820/250	20 + 20	340/100	2	Som HADT97, uten rørdeler og uten varme i avløp	1207,00
VPH-350	350	-	-		-	45,00
VPS03	1000	730-785	500	21		2572,00
VPS90	1000	700-850	500	22		1490,00



## 8. Kondensvannrør og slange

### 8.1 Rør og -slange

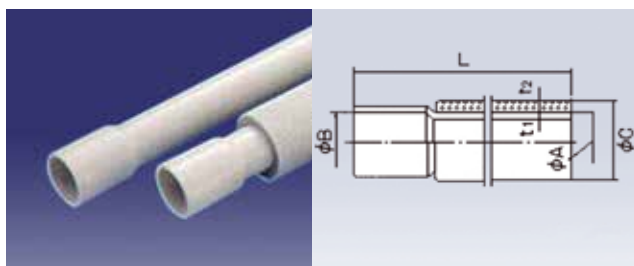

ND – uisolert. NDD – isolert ( $t_2=6$  mm)

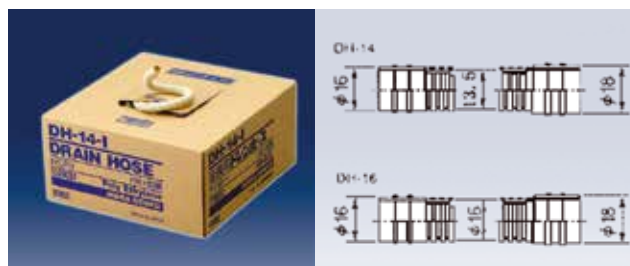

DH-14, DH-16



TU16, TU18  
Spiralslange med glatt inside



DH-7004A med dobbelt lag.  
Svart inside.

Artikkelnummer	A (mm)	B (mm)	C (mm)	L (m)	t1 (mm)	Farge	Antall/pakke	Pris NOK/stk.
NDD-20	26	26,45	38	2,5	2,7	Grå-Beige	16	280,00
ND-20	26	26,45	–	2,5	2,7	Grå-Beige	30	140,00
DH-14	14	16	–	50	2	Grå-Beige	8	530,00
DH-16	16	16	–	50	2	Grå-Beige	6	619,00
TU16	16	18	–	30	2	Grå	1	457,00
TU18	18	20	–	30	2	Grå	1	500,00
DH-7004A	16	16	–	50	2	Beige/sort	1	425,00

## 8. Kondensvannrør og slange

### 8.2 Rørdeler til kondensvannrør

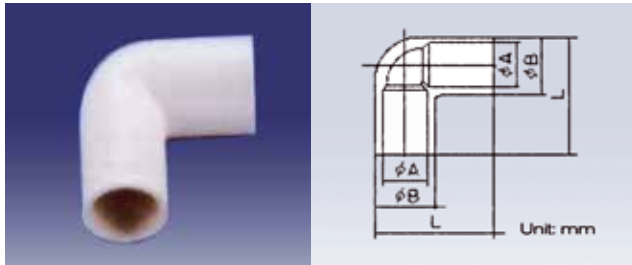

NDE-20, 90 grader

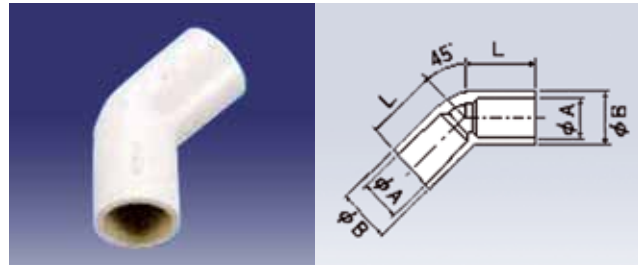

NDF-20, 45 grader

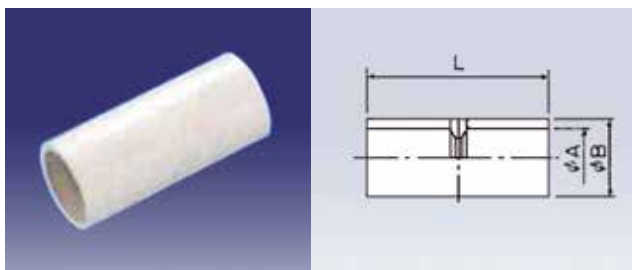

NDS-20, muffe

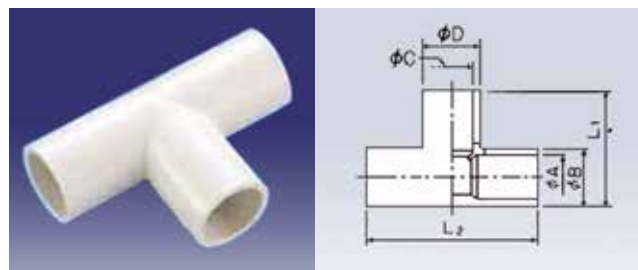

NDT-20, T-rør

Artikkelnummer	A (mm)	B (mm)	C (mm)	L (mm)	L1 (mm)	L2 (mm)	Antall/pakke	Pris NOK/stk.
NDE-20	26,45	33	–	66,5	–	–	200	22,00
NDF-20	26,45	33	–	44	–	–	100	22,00
NDS-20	26,45	33	–	44	–	–	200	15,00
NDT-20	26,45	33	26,45	–	66,5	100	100	26,00

Farge: Grå-beige

## 8. Kondensvannrør og slange

### 8.3 Tilbehør til kondensvannrør og -slange



NDH-14S, kobling mellom slange DH-14 og rør ND-20

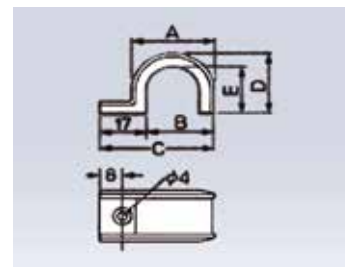

DS-14



VPH-20, rørholder for ND-20

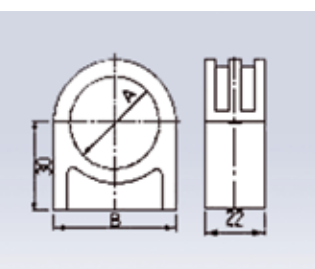

DY-14, treveis og DHJ-14 rett muffe for DH-14 og DH-16



DHB-1416 Vannlås for kondensvannrør

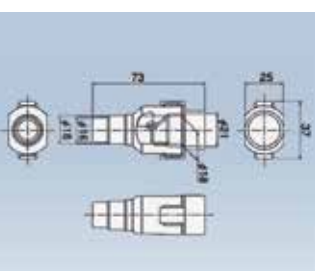

DC-1416



TUGY 21

Artikkelnummer	A (mm)	B (mm)	C (mm)	D (mm)	L (mm)	L1 (mm)	L2 (mm)	Antall/pakke	Pris NOK/stk.
NDH-14S	–	–	–	–	–	–	–	100	74,00
VPH-20-I	26	37	–	–	–	–	–	10	59,00
DY-14	–	–	–	–	–	–	–	10	52,00
DHJ-14	21,9	–	–	–	28	–	–	10	25,00
DHJ-16	24,4	–	–	–	28	–	–	10	27,00
DS-14	26,6	18	39,3	23	19	–	–	50	9,00
DHB-1416	–	–	–	–	–	–	–	50	203,00
DC-1416	24	–	–	–	20	–	–	2	70,00 for 2 stk.
TUGY	Y-kobling til kondensvannslange TU 16 og TU 18							20	47,00

## 9. Kondensvannpumper

### 9.1 Pumper



Løfth.	Pumpkapasitet (lit/h)			
	Slangens lengde			
	5 m	10 m	20 m	30 m
0 m	20	19	18	17
2 m	16	15	14	13
4 m	11	10	9	9
6 m	–	8	7	6
8 m	–	6	5	4
10 m	–	4	3	2



Sauermann SI-30

Sauermann SI-10  
med integrert giverdel



Sauermann SI-1805

Sauermann SI-82

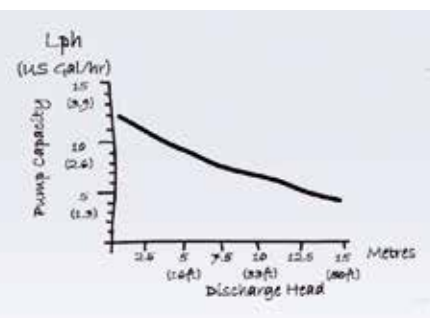

EDC Limpet LIM 6000

Artikkelnummer	Kap. lit/tim 2 m løfth.	Maks løfth. (m)	Maks slanglengde (m)	Effekt (W) 230V/50 Hz	Dim. (mm) L x B x H	Tankvolum (L)	Pris NOK/stk.
SI-10	16	10	30	14	66x44x77	-	1999,00
SI-30	16	10	30	14	66x44x60	-	2097,00
LIM6000	10	20	60	17	286x61x53	-	1984,00
SI-1805	500	5,4	60	90	195x130x122	0,5	1783,00
SI-82	500	5,4	60	70	279x130x175	2,0	1806,00

## 9. Kondensvannpumper

### 9.2 Plastslanger og tilbehør

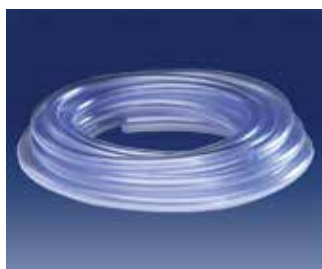

Plastslange  
ACC



Armert plastslange  
PSA

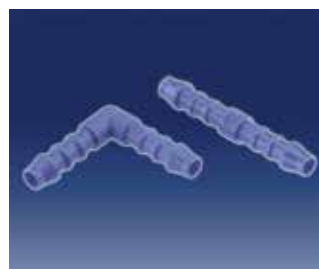

Koblinger  
ACC00204



Tilkobling soil  
ACC00205

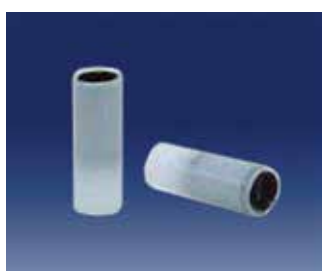

Kontraventil for  
10 mm slange  
ACC00801

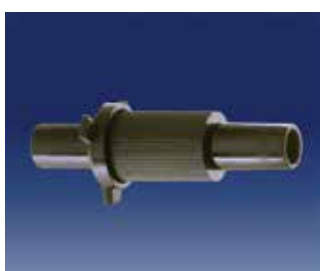

Kontraventil for  
6 mm slange  
ACC00805

Artikkel-nummer	Beskrivelse	Dimensjon	Beskrivelse	Antall/pakke	Pris NOK /pakke
ACC00105	Plastslange	Ø 6 mm L = 5 m	Passer til minipumpe	1	126,00
ACC00125	Plastslange	Ø 10 mm L = 25 m	Passer til pump m tank	1	556,00
ACC00150	Plastslange	Ø 6 mm L = 50 m	Passer til minipumpe	1	457,00
PSA-0610	Armert plastsl.	Ø 6 mm L = 100 m		1	695,00
PSA-1620	Armert plastsl.	Ø 16 mm L = 50 m		1	596,00
ACC00126	Armert plastsl.	Ø 10 mm L = 25 m		1	693,00
ACC00151	Armert plastsl.	Ø 6 mm L = 50 m		1	1031,00
ACC00204	Koblinger	Ø 6 mm	5 st 90°, 5 st rett	10	315,00
ACC00205	Fitting for slange	Ø 6 mm	Tilkobling soil	6	456,00
ACC00801	Kontraventil	Ø 10 mm	For 10 mm slange	1	108,00
ACC00805	Kontraventil	Ø 6 mm	For 6 mm slange	5	375,00

## 9. Kondensvannpumper

### 9.2 Plastslanger og tilbehør, forts.



Muffe 90° av gummi  
ACC00208

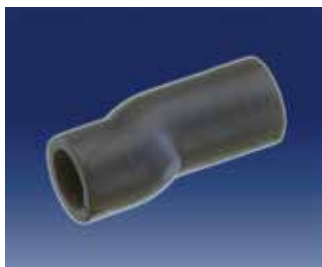

Muffe S-typ av gummi  
ACC00209

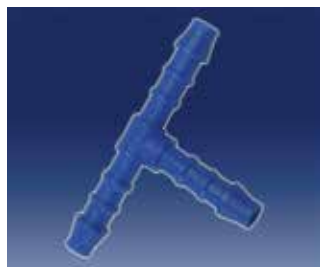

T-rør  
ACC00211



Plastflaske med pip  
ACC00401



T-Kobling. Motvirker hevert-  
virkning

Artikkel- nummer	Beskrivelse	Dimensjon	Beskrivelse	Antall/ pakke	Pris NOK /pakke
ACC00208	Muffe av gummi	Ø 15 x 15 mm	90° passer til minipumpe	1	84,00
ACC00209	Muffe av gummi	Ø 15 x 15 mm	"S-typ" passer minip.	1	84,00
ACC00211	T-rør	Ø 6 mm		5	213,00
ACC00401	Plastflaske	Med pip	For fylling av slange	1	396,00
ACC00214	T-rør	Ø 6 mm	Motvirker hevertvirkning	1	452,00

## 10 Frostsikringskabel (neste side)

Artikkel- nummer	Beskrivelse	Dimensjon	Beskrivelse	Antall/ pakke	Pris NOK /pakke
1054430	Frostsikringskabel	2 m	Selvregulerende, 9 W/m	1	829,50
1054431	Frostsikringskabel	4 m	Selvregulerende, 9 W/m	1	966,00
1054432	Frostsikringskabel	6 m	Selvregulerende, 9 W/m	1	1312,50
1054433	Frostsikringskabel	8 m	Selvregulerende, 9 W/m	1	1564,50
1054434	Frostsikringskabel	10 m	Selvregulerende, 9 W/m	1	1890,00
1054435	Frostsikringskabel	15 m	Selvregulerende, 9 W/m	1	2467,00
1054436	Frostsikringskabel	20 m	Selvregulerende, 9 W/m	1	3097,50
1054437	Frostsikringskabel	25 m	Selvregulerende, 9 W/m	1	3622,50



## 10. QsanTec Varmekabel og frostsikringskabel



Varmekabel uten termostat



Varmekabel med termostat



Termostat

Varmekabelen består av enkeltledere, som gjør den meget "formbar" og lett og montere. Varmekabel med termostat (VK75T) er i tetthetsgrad IP44. (Sprutsikker).

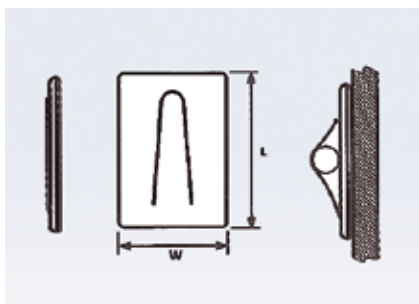

Selvklebende kabelholder



Varmekabel, type VK m/termostat



Varmekabel selvregulerende, forskjellige lengder (se nederst på forrige side)

Materialdata: Galvanisert stål. Farge: hvit. Lim: Akryl med base av polyetelen skum. Temp.område:  $-40^{\circ}\text{C}$  till  $+70^{\circ}\text{C}$ .

Artikkel-nummer	Beskrivelse	Varm lengde/ total lengde	Effekt (W) 230 V	Beskrivelse	Pris NOK/stk.
VK75	Varmekabel u. termostat	1,5 m/2,5 m	75	Silikonkabel, Ø 6 mm	147,00
VK75T	Varmekabel m. termostat	1,5 m/2,5 m	75*	Silikonkabel, Ø 6 mm	200,00
VT308	Termostat, typ klixon	0 m/0,6 m	–	Til $+3^{\circ}\text{C}$ , Från $+8^{\circ}\text{C}$	80,00
VKSAC2	Selvklebende kabelholder	–	–	38x25 mm, maks Ø 8 mm	12,00
VK50T2P	Varmekabel for drenerør	2/4 m	50	Med termostat	446,00
VK100T4P	Varmekabel for drenerør	4/6 m	100	Med termostat	624,00
VK150T6P	Varmekabel for drenerør	6/8 m	150	Med termostat	803,00
VK25-2	Varmekabel u. termostat	1 m/2 m	25	Silikonkabel, Ø 6 mm	294,00
VK80-5	Varmekabel u. termostat	4m/5m	80	Silikonkabel, Ø 6 mm	546,00
VK100-3	Varmekabel u. termostat	2m/3m	100	Silikonkabel, Ø 6 mm	577,00

## 11. Kabel

### 11.1 Installasjonskabel EKK/PFXP



EKK/PFXP

#### ANVENDELSE

**Anvendelse:** EKK-light kan legges åpent eller i rør og kanaler. Godkjent for både inne og utebruk.

**Ledertemperatur:** Maks. 70°C

**Kortslutningstemperatur:** Maks. 150°C

**Installasjonstemperatur:** Min. 0°C

**Bøyeradius:** 8 x diameter

#### KONSTRUKSJON

**Ledere:** En tråd av glødd kobber

**Isolering:** Blyfri PVC

**Partsmerking med jording:**

3-leder: Grønn/gul, blå, brun

4-leder: Grønn/gul, blå, brun, svart

5-leder: Grønn/gul, blå, brun, svart, grå

**Fyllmantel:** Blyfri PVC

**Mantel:** Blyfri PVC

**Mantelfarge:** Hvit

Artikkel-nummer	E-nummer	Antall ledere area (mm <sup>2</sup> )	Ytterdiam. (mm)	Vekt (Kg/1000m)	Forpakning (meter)	Pakke	Pris NOK /meter
EKK 315-50	1018670	3G/1,5	9,1	135	50	Kveil	1216,00
EKK 415-50	1018680	4G/1,5	9,8	161	50	Kveil	1638,00
EKK 515-50	0411441	5G/1,5	10,8	195	50	Kveil	2047,00
EKK 325-50	1018671	3G/2,5	8,0	188	50	Kveil	1905,00
EKK 525-50	1018691	5G/2,5	12,4	277	50	Kveil	3319,00
PFXP 4G		4G/1,5	9,8	161	50	Kveil	1638,00

## 11. Kabel

### 11.2 Tilslutningskabel



Kabel med stikk-kontakt, jordet



Kabel med stikk-kontakt, jordet, svart

Artikkelnummer	Lederantall/ area (mm)	Ytterdiam. (mm)	Lengde (meter)	Pris NOK/stk.
EPC-3	3G/1,5	10	3,0	126,00
EPC-7	3G/1,5	10	7,0	220,00
EPCR-2	3G/1,5	10	2,0	136,00

Støpsel, jordet, vinkel  
EHSK01Støpsel, jordet rett, IP 44  
EHSK02

Artikkelnummer	Benevning	Lederantal	Merkestrøm	Pris NOK/stk.
EHSK01	Stikk-kontakt, sideuttak	2 + jord	16 A/250 V	32,00
EHSK02	Stikk-kontakt, rak	2 + jord, IP44	16 A/250 V	32,00

## 12. Bryter og strømbrytere



EBG316 V

Tre-polet strømbryter av slagfast, isolerende, korrosjonsbestandig og halogenfritt materiale. Kapslingsklasse IP 65. GARO strømbrytere er utført og prøvet i henhold til EN 60 947-3. CE merket. 16 A, PG- M25.

Artikkelnummer	Beskrivelse	Maks strøm (A)	Maks kabel (mm <sup>2</sup> )	Dimensjon HxBxD (mm)	Antall/pakke	Pris NOK/stk.
EBG316V	3-polet strømbryter	16	6	137x116x62	10	353,00



Topolet sikkerhetsbryter



Trepolet sikkerhetsbryter

Sikkerhetsbryteren er produsert i slagfast termoplast (PBT). Merke: ABB. Max IP 65 ved bruk av PG-nippel. Ved bruk av gummimembran IP 54.

Artikkelnummer	Beskrivelse	Maks strøm ved 400 V (A)	Maks kabel (mm <sup>2</sup> )	Pris NOK/stk.
EBW225	Topolet sikkerhetsbryter	25	4	355,00
EBW325	Trepolet sikkerhetsbryter	22	4	394,00

## 13. EI-materiell



EAP10



Koblingsboks, EAP9



Dekklokk 100 mm



Wago



Lysterklemme Hvit

Lysterklemme,  
typ U

Strekavlaster

Artikkelnummer	Beskrivelse	Dimensjon LxHxD (mm)	Beskrivelse	Antall/pakke	Pris NOK/stk.
EAP9	Koblingsboks, liten	86x86x38	IP55, 2,5 mm <sup>2</sup> /400V, tom	1 (5)	53,00
EAP10	Koblingsboks, stor	104x104x46	IP55, 6,0 mm <sup>2</sup> /400V, tom	1 (5)	149,00
EAP6	Koblingsboks, liten	60x60x28	IP20, 5 polet kobling	1 (10)	76,00
EAP12	Koblingsboks, stor	59x74x32	IP20, 3 polet kobling	1 (10)	79,00
EAK11	Dekklokk, skruer	Ø 100	For koblingsbokser	1 (50)	22,00
EAK12	Dekklokk, snapp	Ø 100	For koblingsbokser	1 (20)	26,00
EAK13	Dekklokk m/utg, skru	Ø 100	For koblingsbokser	1 (20)	30,00
EAK14	Dekklokk m/utg, snapp	Ø 100	For koblingsbokser	1 (20)	34,00
EAS9	Strekavlaster	–	Med 5-polet kobling Pas-ser for EAP9 og EAP10	1	53,00
EKA24212	Lysterklem. (sukkerbit) rett	Max 4 mm <sup>2</sup>	Uten stopp	12	44,00
EKB24212	Lysterklem. (sukkerbit) rett	Max 4 mm <sup>2</sup>	Med stopp	12	54,00
ESP016	Lysterklemmer Type U	Max 5 mm <sup>2</sup>	Type U-klemme	10	20,00
222-412	Wago	2x2,5	–	100	11,00
222-413	Wago	3x2,5	–	50	15,00
222-415	Wago	5x2,5	–	40	23,00

## 14. Festemateriell

### 14.1 Treskrue, gipsanker og montasjeskruer



Gipsanker



Montasjeskrue



Spikerplugg 175471/175472



Råtass/Tingstad



SPIT S 14

Artikkel-nummer	Beskrivelse	Lengde (mm)	Diameter (mm)	Bits	Antall/pakke	Pris NOK /pakke/stk
FMG4535	Gipsanker med skrue	38-35	6.0-4.5	PH 2	100	607,00
FMS4225	Montasjeskrue MS	25	4.2	PH 2	500	235,00
FMS4245	Montasjeskrue MS	45	4.2	PH 2	250	248,00
FGS3940	Gipsskrue for tre	40	3.9	PH 2	500	404,00
115903	Råtass/Tingstad	50	8	M13	100	6,00
115909	Råtass/Tingstad	75	14-10	M 15	50	16,00
115910	Råtass/Tingstad	100	14-10	M 15	25	18,00
187574	SPIT S 14	70	14	–	20	16,00
175471	SPIT M spikerplugg	37	6	–	100	300,00
175472	SPIT M spikerplugg	50	6	–	100	400,00



## 14. Skruv, plugg og klammer

### 14.2 Plastplugg, spikeklammer og stripsholder



Plastplugg typ EH



Plastplugg typ FPL



Clipsplugg TPC



Spikerklammer



Skru eklammer



Klammer TTK



ETS410



SL-300

Artikkelnummer	Beskrivelse	Diameter (mm)	Lengde (mm)	Farge	Antall /pakke	Pris NOK /pakke
EH0525	Plastplugg 5x25	5	25	Grå	300	50,00
EH0630	Plastplugg 6x30	6	30	Grå	300	60,00
EH0840	Plastplugg 8x40	8	40	Grå	100	63,00
EH1050	Plastplugg 10x50	10	50	Grå	50	42,00
FPL1045	Plastplugg 10x45	10	45	Blå	100	211,00
FPL5535	Plastplugg 5,5x3,5	5,5	35	Rød	100	115,00
EHT0710	Spikerklammer 7-10	7-10	–	Hvit	100	31,00
EHT1014	Spikerklammer 10-14	10-14	–	Hvit	100	35,00
EHTCS0710	Skru eklammer 7-10	7-10	–	Hvit	100	407,00
EHTCS0812	Skru eklammer 8-12	8-12	–	Hvit	100	407,00
EHTCS1822	Skru eklammer 18-22	18-22	–	Hvit	100	407,00
EHTKK0710	Klammer TTK	7-10	–	Hvit	100	258,00
EHTCP15	Clipsplugg	4	15	Hvit	100	173,00
ETS200	Strips 200	B=4.8	200	Transp.	100	58,00
ETS300	Strips 300	B=4.8	300	Transp.	100	90,00
ETS2	Stripsholder, liten	B=9	15	Transp.	100	47,00
ETS410	Stripsholder, stor	B=16	22	Hvit	100	404,00
SL-300	Strips med holder	B=8	300	Transp.	10	84,00

## 14. Festemateriell

2014  
2015

### 14.3 Bits



Phillips kryssbits PH2

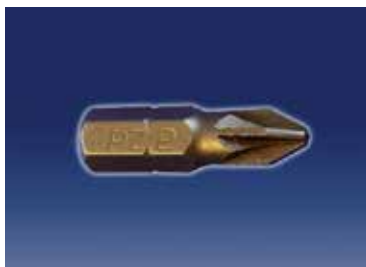

Pozidrive kryssbits PZ2



Pozidrive kryssbits PZ3



Pozidrive kryssbits PZ4



Torxbits TX30

Artikkel-nummer	Beskrivelse	Lengde (mm)	Antall /pakke	Pris NOK/stk.
FBPH2	Phillips kryssbits PH2	50	1	42,00
FBPZ2	Pozidrive kryssbits PZ2	25	1	21,00
FBPZ3	Pozidrive kryssbits PZ3	25	1	21,00
FBPZ4	Pozidrive kryssbits PZ4	32	1	85,00
FBTX30	Torxbits TX30	25	1	26,00

## 15. Hullsager

### 15.1 Diamanthullsager



Diamanthullsag  
HDC68-150



Borholder  
HHB6876-SDS



Borholder  
HHB6876-HEX



Bor  
HHB6876-B



Forlengere  
HHB6876-F

Artikkel-nummer	Beskrivelse	Diam. (mm)	Lengde (mm)	Anmerkning	Nettopris NOK/stk.
HDC64-150	Diamanthullsag	64	150	Leveres uten borholder	611,00
HDC68-150	Diamanthullsag	68	150	Leveres uten borholder	626,00
HDC73-150	Diamanthullsag	73	150	Leveres uten borholder	649,00
HDC76-150	Diamanthullsag	76	150	Leveres uten borholder	676,00
HHB6876-SDS	Borholder SDS-plus	–		Til HDC68-150/HDC76-150	110,00
HHB6876-HEX	Borholder sekskant	–		Til HDC68-150/HDC76-150	110,00
HHB6876-F	Forlenger	–		Til HDC68-150/HDC76-150	177,00
HHB6876-B	Bor	–		Til borholder over	30,00

\* Bruke borholder HHBA 10 eller HHBA 21 (SDS-plus).

## 15. Hullsager

2014  
2015

### 15.2 Hardmetallhullsager

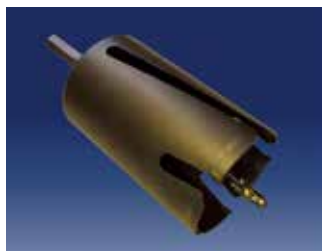

Hardmetallhullsag  
HHC70-HHC76



Borholder SDS  
HHB76-H

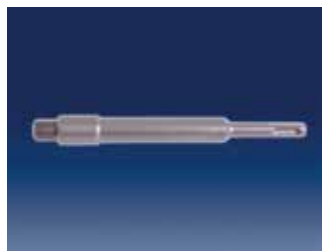

Borholder XL, SDS  
HHB76-XLSDS

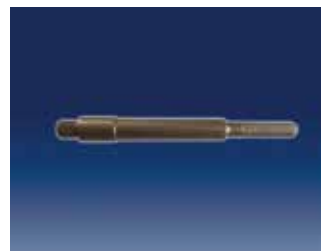

Borholder XL, HEX  
HHB76-XL

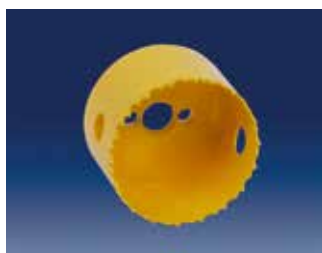

Hardmetallhullsag  
HHDH

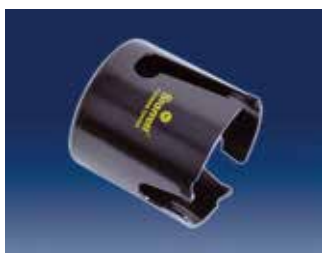

Hardmetallhullsag  
HHMPH



Borholder  
HHBA10



Borholder  
HHBA21

Artikkelnummer	Beskrivelse	Diam. (mm)	Lengde (mm)	Anmerkning	Nettopris NOK/stk.
HHC70	Hardmetallhullsag	70	130	Lev. med borholder sekskant	1138,00
HHC76	Hardmetallhullsag	76	130	Lev. med borholder sekskant	1238,00
HHB76-D	Borholder SDS-plus	–	–	Brukes til HHC70/76	150,00
HHB76-HB	Bor til HHC70/76	8,0	165	Passer ikke til borholder XL	80,00
HHB76-XL	Borholder XL-HEX	–	180	Brukes til HHC70/76	210,00
HHB76-XLSDS	Borholder XL-SDS	–	180	Brukes til HHC70/76	208,00
HHDH0212	Hardmetallhullsag DH	64	54	Dual Pitch. Uten borholder*	143,00
HHDH0258	Hardmetallhullsag DH	67	54	Dual Pitch. Uten borholder*	150,00
HHDH0234	Hardmetallhullsag DH	70	54	Dual Pitch. Uten borholder*	150,00
HHMPH64	Hardmetallhullsag	64	54	Leveres uten borholder*	204,00
HHMPH67	Hardmetallhullsag	67	54	Leveres uten borholder*	224,00
HHMPH70	Hardmetallhullsag	70	54	Leveres uten borholder*	224,00
HHMPH73	Hardmetallhullsag	73	54	Leveres uten borholder*	231,00
HHMPH76	Hardmetallhullsag	76	54	Leveres uden borholder*	235,00
HHBA10	Borholder MPH 9,5	–	–	Bores diameter, 9,5 mm	200,00
HHBA21	Borh. MPH SDS-plus	–	–	SDS-plus	518,00
HHBA15-F	Forlenger	–	300	Passer til HHBA10	342,00
HHBA-B	Bor til HHMPH	9,5	–	–	62,00

\* Bruk borholder HHBA 10 eller HHBA 21 (SDS-plus).

## 16. Servicemanometer og slanger

### 16.1 Servicemanometer



VB49936 og VB49969  
Servicemanometer 4-veis.  
Titan for R410A, R404A og  
R407C.



VB40812  
Servicemanometer



N2 regulator



VB49190  
Beskyttelse av gummi



VB40944 og VB41332  
Servicemanometer 2-veis.  
Serie 41 for R410A, R404A og  
R407C.



999. Service-  
manometer HP-410



VB40852  
Servicemanometer

Artikkelnummer	Beskrivelse	Dimensjon	Leve- randør	Antall/ pakke	Nettopris NOK/stk.
VB49969	Servicemanometer 4-veis Titan R410A	1/4"-Vakuüm 3/8" Manom. -80 mm Class 1	Yellow Jacket	1	1601,00
VB49936	Servicemanometer 4-veis Titan R134a, R404A, R407C	1/4"-Vakuüm 3/8" Manom. -80 mm Class 1	Yellow Jacket	1	1601,00
VB40944	Servicemanometer 2-veis Serie 41, R410A	1/4" Manometer -68 mm. Class 1	Yellow Jacket	1	720,00
VB41332	Servicemanometer 2-veis Serie 41, R134a, R404A, R407C	1/4" Manometer -68 mm. Class 1	Yellow Jacket	1	720,00
VB49190	Beskyttelse. Gummi. Rød-Blå	80 mm	Yellow Jacket	2	168,00 for 2 stk.
VB40812	Yellow Jacket digitalt manometersett med logg og analyse. Innebygd vakuümeter til 10 micron. Kan måle på 100 forskjellige kuldemedier med valg av favoritter. Viser og lagrer max- og min-trykk. USB for overføring til excel.	Tilslutning 1/4"	Yellow Jacket	1	7695,00
VB40852	Yellow Jacket digitalt manometersett. Kobles til ditt eksisterende 2-veis manometersett for digital avlesning. Kan måle på 100 forskjellige kuldemedier med valg av favoritter.	Tilslutning 1/4"	Yellow Jacket	1	1996,00
999	Servicemanometer HP. R410A*	Tilslutning 5/16"	-	1	490,00

\* Anbefaler å bruke sammen med VBTA 166-2, se side 57.

## 16. Servicemanometer og slanger

### 16.2 Slanger



VA679A. Slange 3-pakk.  
Ingen ventil



VA679A-AV. Slange 3-p.  
med automatventil



VA679A-MV. Slange 3-pakk  
med kulventil



VA679B. Slange 3-pakk.  
R410A ingen ventil



VAH336. Slange  
3-pakk. 1/4", 0,9 m



VAH 360. Slange 3-pakk. 1/4",  
1,5 m



VA29483/5 og VA29983. Slange  
3-pakk med kompakte kulventil  
(CV)



VA679B-MV. Slange 3-pakk.  
R410A med kulventil

Artikkelnummer	Beskrivelse	Lengde (m)	Tilslutning	Dim.	Antall/pakke	Nettopris NOK/pak.
VA679A	Slanger 3-p. R410A, ingen ventil	0,9	Blå 1/4"-5/16" Gul 1/4"-1/4" Rød 1/4"-5/16"	1/4"	3	245,00
VA679A-AV	Slanger 3-p. R410A, schrader	0,9	Blå 1/4"-5/16" Gul 1/4"-1/4" Rød 1/4"-5/16"	1/4"	3	359,00
VA679A-MV	Slanger 3-p. R410A, kulventil	0,9	Blå 1/4"-5/16" Gul 1/4"-1/4" Rød 1/4"-5/16"	1/4"	3	532,00
VA679B	Slanger 3-p. R410A, ingen ventil	1,5	Blå 1/4"-5/16" Gul 1/4"-1/4" Rød 1/4"-5/16"	1/4"	3	415,00
VA679B-MV	Slanger 3-p. R410A, kulventil	1,5	Blå 1/4"-5/16" Gul 1/4"-1/4" Rød 1/4"-5/16"	1/4"	3	508,00
VAH336	Slanger 3-p. HFC, ingen ventil	0,9	Blå 1/4"-1/4" Gul 1/4"-1/4" Rød 1/4"-1/4"	1/4"	3	252,00
VAH360	Slanger 3-p. HFC, ingen ventil	1,5	Blå 1/4"-1/4" Gul 1/4"-1/4" Rød 1/4"-1/4"	1/4"	3	306,00
VA29483	Slanger 3-p. R410A, CV kulventil	0,9	Blå 1/4"-5/16" Gul 1/4"-1/4" Rød 1/4"-5/16"	1/4"	3	950,00
VA29485	Slanger 3-p. R410A, CV kulventil	1,5	Blå 1/4"-5/16" Gul 1/4"-1/4" Rød 1/4"-5/16"	1/4"	3	1140,00
VA29983	Slanger 3-p. HFC, CV kulventil	0,9	Blå 1/4"-1/4" Gul 1/4"-1/4" Rød 1/4"-1/4"	1/4"	3	1014,00
VA21485	Slanger 3-p. HFC, ingen ventil	1,5	Blå 1/4"-5/16" Gul 1/4"-1/4" Rød 1/4"-5/16"	1/4"	3	997,00
VA21985	Slanger 3-p. HFC, ingen ventil	1,5	Blå 1/4"-1/4" Gul 1/4"-1/4" Rød 1/4"-1/4"	1/4"	3	997,00



## 16. Servicemanometer og slanger

### 16.3 Vakuumslinger



Vakuumslange 3/8"  
0,9 m



Vakuumslange 3/8"  
1,5 m



Vakuumslange 1/4"  
1,5 m



Schraderåpner

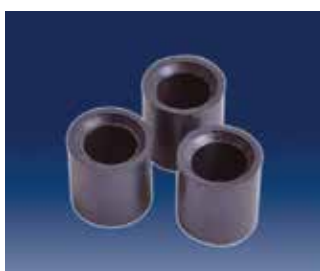

Gummipakning



Teflonpakning

Artikkelnummer	Beskrivelse	Lengde (m)	Tilslutning	Dim.	Antall/pakke	Nettopris NOK/pak.
VA18160	Vakuumslange, gul	1,5	3/8" SAE	3/8"	1	570,00
VA20436	Vakuumslange, gul	0,9	1/4" SAE	3/8"	1	475,00
VA21060	Vakuumslange, gul	1,5	1/4" SAE	1/4"	1	215,00
VAHD-1	Schraderinnsats	–	–	1/4"	1	16,00
VAHD-2	Schraderåpner	–	–	1/4"	1	16,00
VAHP-1G	Gummipakning for slange	–	–	1/4"	1	16,00
VAHP-2	Teflonpakning for slange	–	–	1/4"	1	16,00
VAHP-3	Teflonpakning for slange	–	–	5/16"	1	16,00
VA19011	Gummipakning for slange	–	Yellow Jacket	3/8"	1	21,00
VA19020	Gummipakning for slange	–	Yellow Jacket	1/4"	1	26,00

## 17. Nøkler og tenger

2014  
2015



TA771-BH Momentnøkkelsett  
R410A. 1/4"-3/8"



TA771L-2, TA771R-2  
Momentnøkkel



Punkteringstang



Skralle 1/4"-3/8"



Pinch-off tang

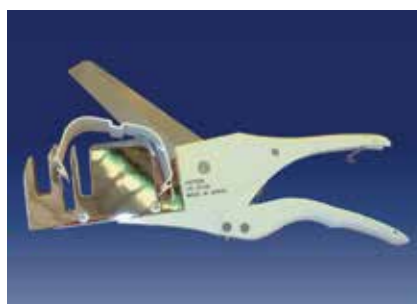

VD-2100 og VD-2200  
Kanaltang

Artikelnummer	Beskrivelse	Dim.	Beskrivelse	Dim. nøkkelvidde (mm)	Nettopris NOK/stk.
TA771BH	Momentnøkkel R410A	1/4"-3/8"	2 st nøkler med etui	17-22	2099,00
TA771L-2	Momentnøkkel R410A	1/2"	1 st nøkkel (ryms i etui ovan)	26	1085,00
TA771R-2	Momentnøkkel R410A	5/8"	–	29	1645,00
VCT-122	Skralle	1/4"-3/8" 3/16"-5/16"	Firkantet grep	–	50,00
VCT-123L	Skralle	1/4"-1/2" 9/16"-3/16"	Firkantet grep	–	56,00
VCT-201	Pinch-off tang	175 mm	–	–	76,00
VC60667	Punkteringstang	–	–	–	416,00
VD-2100	Kanaltang	70-100 mm	Brukes for SD-77, SD-100, GG, BC		1337,00
VD-021	Blad til kanaltang VD-2100		Brukes for VD-2100		390,00
VD-2200	Kanaltang	70-100 mm	Brukes for MDZ, NSD, QD		1337,00

## 18. Bøyeverktøy, rørkutter og flareverktøy

### 18.1 Bøyeverktøy og speil

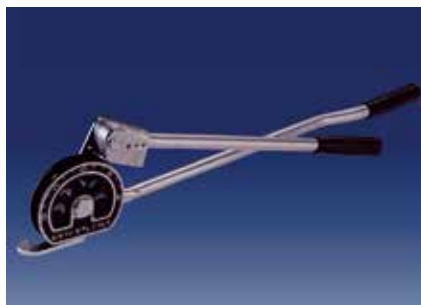

VCT-364A-06  
Bøyeverktøy 3/8"



VCT-364A-08  
Bøyeverktøy 1/2"



VCT-368  
Bøyeverktøy 1/4"-5/16"-3/8"



VCT-369  
Bøyeverktøy 1/4"-3/8" (180°)

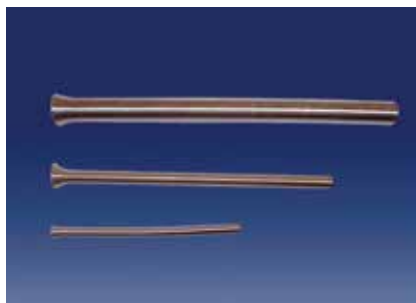

VCT-1932  
Bøye fjærsett 1/4"-5/8"



Speil av glass

Artikkelnummer	Beskrivelse	Dimensjon	Beskrivelse	Nettopris NOK/stk.
VCT-364A-06	Bøyeverktøy	3/8"	–	210,00
VCT-364A-08	Bøyeverktøy	1/2"	–	283,00
VCT-364A-10	Bøyeverktøy	5/8"	–	420,00
VCT-364A-12	Bøyeverktøy	3/4"	–	515,00
VCT-368	Bøyeverktøy	1/4"-5/16"-3/8"	Bøyer 90°	84,00
VCT-369	Bøyeverktøy	1/4"-5/16"-3/8"	Bøyer 180°	86,00
VCT-1932	Bøye fjærsett	1/4"-3/8"-1/2"-5/8"	Sett med 4 bøye fjærer	62,00
VCT-19322	Bøye fjær	1/4"	–	15,00
VCT-19323	Bøye fjær	3/8"	–	18,00
VCT-19324	Bøye fjær	1/2"	–	20,00
VCT-19325	Bøye fjær	5/8"	–	22,00
VC 78098	Speil av glass	Diameter: 30 mm	–	91,00

## 18. Bøyeverktøy, rørkutter og flareverktøy

### 18.2 Rørkutter



VCUP-351L Rørkutter 1/4"-7/8"



Rørkutter TA560H



Rørkutter TA560A



Rørkutter TA560AF

Artikkelnummer	Beskrivelse	Dimensjon	Beskrivelse	Nettoppris NOK/stk.
VCUP-351L	Rørkutter	1/4"-7/8"	Med sperrefunksjon	185,00
TA560H	Rørkutter, mini	1/8"-5/8"	Tasco Japan	344,00
TA560A	Rørkutter	1/4"-1 1/8"	Ekstra tynt kutterhjul	390,00
TA560AF	Rørkutter	1/4"-1 1/8"	Med fjærfunksjon	390,00
VCUP-351L-BD	Kutterhjul til VCUP-351L	–	–	34,00

## 18. Bøyeverktøy, rørkutter og flareverktøy

### 18.3 Gradverktøy



VCT-208  
Gradverktøy 1/4"-1,1/2"



VCT-207  
Gradverktøy m roterende kniv



VCTA535M  
Gradverktøy med håndtak



Brotch. TA692R-2

Artikkelnummer	Beskrivelse	Dimensjon	Beskrivelse	Nettopris NOK/stk.
VCT-208	Gradverktøy	1/4"-1 1/2"	Grading av inner og ytter	47,00
VCTA535M	Gradverktøy m håndtak	1/4"-5/8"	Grading av inner	189,00
VCT-207	Gradverktøy med kniv	-	Grading av inner	83,00
TA692R-2	Brotch	1/4"-5/8"	Grading av inner	488,00



## 18. Bøyeverktøy, rørkutter og flareverktøy

### 18.4 Flareverktøy



TA550N  
Tasco flareverktøy



TA55-DT  
Tasco flareverktøysett



VCT-100AL1  
Blokkeverktøy



VCT-806-A  
Asian First flareverktøy



VCT-806AL  
Flareverktøysett



VCT-351  
Finnekam/plast



VCT-352  
Finnekam/rustfri



Esterolje

Artikkelnummer	Beskrivelse	Dimensjon	Beskrivelse	Nettopris NOK/stk.
TA550N	Flareverktøy	1/4"-5/16"-3/8" 1/2"-5/8"-3/4"	Tasco, Japan	2388,00
TA55DT	Flareverktøysett i koffert	1/4"-5/16"-3/8" 1/2"-5/8"-3/4"	Inneholder: 1 st TA 550D 1 st rørkutter 1 st gradverktøy Drill kan anvendes	4515,00
VCT-806A	Flareverktøy	1/4"-5/16"-3/8" 1/2"-5/8"-3/4"	Asian First, Taiwan	860,00
VCT-806AL	Flareverktøysett	1/4"-5/16"-3/8" 1/2"-5/8"-3/4"	Inneholder: 1 st VCT 806A 1 st rørkutter VCT-274 1 st gradverktøy VCT-208	1062,00
VCT-100AL1	Blokkeverktøy	3/8"-7/8"	For blokking av rør	1419,00
VCT-351	Finnekam/plast	-	-	46,00
VCT-352	Finnekam/rustfri	-	-	46,00
VPYOIL ESTER	Esterolje	100 ml	Esterolje for flaring	52,00

## 19. Lekkasje-søker og vakuum-meter



VB69366  
Lekkasje-søker  
Accu Probe



VB69101  
Føler for VB 69086, ny modell



VB69086  
Digitalt vakuummeter



VB69047/VB69048  
Digitalt vakuummeter



Lekkasje-søkerspray



VG100A og VG200



VB69045  
Mekanisk vakuummeter



VB69087  
Givere till elektronisk  
vacuummeter, gammel type

Artikkelnummer	Beskrivelse	Beskrivelse	Nettopris NOK/stk.
CLL01	Lekkasje-søkerspray	400 ml	163,00
VB69366	Lekkasje-søker Accu Probe	Metod: HET. Nøyaktighet: 1,7 gram/år for R134a, R410A, R404A og R407C	4693,00
VB69373	Lekkasje-søker for brennbare medier	Lekkasje-søker for metan, propan, acetylen, butan, isobutan. Nøyaktighet: 2-5 PPM	3412,00
VB69383	Givere til Accu Probe	Giver og fiter	777,00
VB69385	Filter til Accu Probe	5 stk filter	60,00
VB69101	Giver til VB69086	Ny type, med ledning	250,00
VB69371	Giver	Til lekkasje-søker for brennbare medier	250,00
VB69086	Digitalt vakuummeter	Tilslutning: 1/4" flare	2781,00
VG100 A	Elektronisk vakuummeter	LED lampeindikasjon i 9 trinn fra 1 bar til 25 micron	1732,00
VG200	Elektronisk vakuummeter	5 siffer display med mBar og micron	2047,00
VB69087	Giver til VB69086	Giver uten ledning	492,00
VB69045	Mekanisk vakuummeter	Diameter: 80 mm. Tilslutning: 1/8" NPT	338,00
VB69047	Digitalt vakuummeter	Evac i enkel modell 1/4" flare, drift til -12C	2000,00
VB69048	Digitalt vakuummeter	Evac 1/4" flare, programmerbart sluttvakuum, drift til -12C	2500,00

## 20. Vakuumpumpe med tilbehør

2014  
2015



Vakumpumpe VPY15-CH



Vakumpumpe VPY25-CM



Vakumpumpe VPY45-CH



Vakumpumpolje YJ

Artikkelnummer	Beskrivelse	Beskrivelse	Nettopris NOK/stk.
VPY15-CH	Vakumpumpe 2-trinns	Kapasitet: 43 lit/min. Sluttrykk: 25 micron Tilslutninger: 1/4" og 3/8". El: 1/6 hp-220V-50Hz	2257,00
VPY25-CH	Vakumpumpe 2-trinns	Kapasitet: 68 lit/min. Sluttrykk: 25 micron Tilslutninger: 1/4" og 3/8". El: 1/4 hp-220V-50Hz	3486,00
VPY45-CH	Vakumpumpe 2-trinns	Kapasitet: 122 lit/min. Sluttrykk: 25 micron Tilslutninger: 1/4" og 3/8". El: 1/3 hp-220V-50Hz	3942,00
VPYOIL93091	Vakumpumpolje	0,475 liter	110,00
VPYOIL93092	Vakumpumpolje	0,95 liter	157,00

## 21. Tømmeaggregat og vekter



Tømmeaggregat VB95763



Elektronisk vekt



VBRCS-7040

Enkel verktøyboks  
i PP plastKraftig verktøykoffert  
i ABS plastTømmeaggregat VB 95730  
(kommer i august)

Artikkelnummer	Beskrivelse	Beskrivelse	Nettopris NOK/stk.												
VB95763	Tømmeaggregat XLT	Oljefri kompressor, 3425 rpm. Helautomatisk overgang, væske-gass. Motor: 1/2 hp, 220 v – 50 Hz. LED viser ferdig tømning. Fabrikat: Yellow Jacket.  <table border="1"> <thead> <tr> <th>Kapasitet (kg/h)</th> <th>Gas</th> <th>Push/Pull</th> <th>Væske</th> </tr> </thead> <tbody> <tr> <td>R134a</td> <td>9,0</td> <td>367,2</td> <td>54,0</td> </tr> <tr> <td>R410A</td> <td>13,2</td> <td>332,4</td> <td>45,6</td> </tr> </tbody> </table>	Kapasitet (kg/h)	Gas	Push/Pull	Væske	R134a	9,0	367,2	54,0	R410A	13,2	332,4	45,6	10395,00
Kapasitet (kg/h)	Gas	Push/Pull	Væske												
R134a	9,0	367,2	54,0												
R410A	13,2	332,4	45,6												
VB68800	Elektronisk vekt 50 kg	Kapasitet: 50 kg. Nøyaktighet: 0,01 kg–0,05 kg. Overbelastings-sikret. Mål: 228x228x50 mm. Fabrikat: Yellow Jacket.	3196,00												
VBRCS-7040	Elektronisk vekt 100 kg	Nøyaktighet: 0.01 kg-0.1 kg. Mål: 223x223 mm. Fabrikat: DSZH.	1480,00												
VV328PP	Enkel verktøyboks	Mål: 340x270x85 mm med skumplast innvendig.	95,00												
VV374B	Kraftig verktøy-koffert	Mål: 400x310x180 mm med skumplast innvendig.	404,00												
VB95730	Tømmeaggregat XLT	Kommer i August	Pris på forespørsel												

## 22. Måleinstrumenter

### 22.1 Termometere, anemometer og lydnivåmåler



VB69210  
Digitalt termometer



VB69215, VB69220  
Giver til digitalt termometer  
Overflateføler og luftføler



Lydnivåmåler



VB69228  
Termometer IR med pistolgrep



VB68915  
Lufthastighetsmåler



Digitalt håndtermometer  
med alarm

Artikkelnummer	Beskrivelse	Beskrivelse	Nettopris NOK/stk.
VB69210	Digitalt termometer-diff.	Område: $-50^{\circ}\text{C}$ – $+1300^{\circ}\text{C}$ . Nøyaktighet: $0,1^{\circ}\text{C}$ – $1,0^{\circ}\text{C}$ . 2 givere inkludert.	1575,00
VB69220	Overflateføler til VB69210	Område og nøyaktighet som over.	1995,00
VB69215	Luftføler til VB69210	Område og nøyaktighet som over.	1995,00
VB69228	Termometer IR med pistolgrep	Område: $-40^{\circ}\text{C}$ – $+1000^{\circ}\text{C}$ . Nøyaktighet: $\pm 2\%$ eller $2^{\circ}\text{C}$ .	2089,00
VB69239	Digitalt håndtermometer	Med alarm, $-50$ – $+200^{\circ}\text{C}$	328,00
VB68915	Anemometer	Område: 0,6–24 m/s. $-10^{\circ}\text{C}$ – $+50^{\circ}\text{C}$ , RS232-utgang. Nøyaktighet: $\pm 2\%$ . Beregner gjennomstrømmet volum.	3553,00
VB69346	Lydnivåmåler	Måleområde 30-130 dB(A)	3531,00



## 22. Måleinstrumenter

### 22.2 Termometere, anemometer og lydnivåmåler



Center 110 Multimeter V-Ohm-A-Hz



Center 223 Strømtang og digitalt multimeter



Center 306 Proff dobbel temp.logger



Center 382 Elektronisk lekk søker



Center 308 Mini dobbel-termometer



Center 325 dBa Lydmåler



382 Sensor



Leak check

Artikkel-nummer	Beskrivelse	Beskrivelse	Nettopris NOK/stk.
110	Multimeter V-Ohm-A-Hz	Centertek 110 digitalt multimeter AC og DCV 400mV til 600V ACA og DCA 400mA til 10A	1004,00
223	Strømtang og digitalt multimeter AC/DC	AC/DC-A 10-100A Spenning AC/DC 600V 10kOhm-sommer-gjennomgang	1453,00
306	Proff dobbel temp.logger	-50 til 200C oppløsning 0,1C Datalogger med 32000 data, 2 x K-føler med dobbeltvisning	2598,00
308	Mini dobbel-termometer	Min/ Max K-føler -50 til 200C oppl. 0,1C	1201,00
325	dBa Lydmåler	32-130 dBa Max-Min fast/slow	1396,00
382	Elektronisk lekk søker	R410A, R407C, R134a, R507, R404a. Nøy. 3 gr./år 4x AA batt eller adapter.	2171,00
Leak check	Prøveflaske til lekk søker	For Center 382	270,00
382 sensor	Sensor	For Center 382	399,00



## 23. Sveiseutstyr

2014  
2015



Turbo Set 90



Maxy Gas



Oxygen



45% sølv med flux, hardlodd, kobber til messing, messing til stål



15 % søvlodd, kobber til kobber

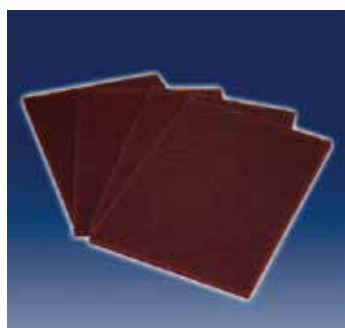

Pusse matte



Flammematte

Turbo Set 90 er et minisveise-apparat med engangs beholdere. (Disse levereres separat).

Max temp: 3050°C  
En oxygen holder ca 80 min ved 0,8 bar.  
En Maxygas holder ca 280 min.

### Settet inneholder:

- Sveisebriller
- Fast nøkkel
- Tenner
- Sveistråd
- Trykregulator for oxygen
- Gassventiler
- Kontraventil
- 2 meter slange med sveisebrenner (80 lit)

Artikkelnummer	Beskrivelse	Mengde	Beskrivelse	Nettopris NOK/stk.
OX115050	Turbo Set 90	-	Med tilbehør, uten gassbeholdere	1184,00
OX480300	Oxygen	1 liter	Stålsylinder	210,00
OX483200	Maxy Gas/Butan	350 gram	-	126,00
15%	Søvlodd	1 stang	15% sølv	89,00
Flammematte	For sikker lodding	1 matte		210,00
Pussematte	3M-matte	1 matte	For rengjøring	42,00
45% sølv		1 stang	Med flux	130,00

## 24. Ventiler og nipler



VB18975



VB18993



VB40323-40324



VBTA166-2



VB19173 - VB19174



VB93844 - VB93846

Artikkelnummer	Beskrivelse	Dimensjon	Beskrivelse	Nettopris NOK/stk.
VB18975	Kuleventilverktøy	1/4"	1. Koble til vakuummeter 2. Ta ut ventil og bytt ventil 3. Tømming av anlegg	577,00
VB18985	Kuleventilverktøy	5/16"	1. Koble til vakuummeter 2. Ta ut ventil og bytt ventil 3. Tømming av anlegg	577,00
VB18973	Pakn. kuleventilverktøy	–	–	68,00
VB19173	Overgang	5/16"-1/4"	5/16" fem.-1/4" male	134,00
VB19174	Overgang	1/4"-5/16"	1/4" fem.-5/16" male	149,00
VB18993	Schraderventilåpner	1/4"	Kun 1/4"	196,00
VBTA166-2	Schraderventilåpner	5/16"	Kun 5/16" TASCO	550,00
VBTS166	Pakning t. VBTA166-2	–		50,00
VB19306	Schraderventilinsats	–	6 stk. i pakke med verktøy	110,00 for 6 stk.
VB41337	Bil-AC kobling Høy	1/4" MF	Kun R134a	446,00
VB41338	Bil-AC kobling Lav	1/4" MF	Kun R134a	446,00
VB93844	Kuleventil 1/4"	1/4" MFLxFFL	Før tømming – fylling	189,00
VB93846	Kuleventil 3/8"	3/8" MFLxFFL	Før tømming – fylling	241,00

## 24. Ventiler og nipler, forts.

2014  
2015



Schradernåluttaker



Adapter 90°



Kuleventil 1/4"



Kuleventil 3/8"



Rett adapter



Fylle nippel  
RCYA 121/RCYA 125

Artikkelnummer	Beskrivelse	Dimensjon	Nettopris NOK/stk.
VBH14301	Schradernåluttaker	1/4" och 5/16"	216,00
VBHAA11	Adapter 90°	1/4" inv. flare QC x 1/4" utv. flare	35,00
VBHAA15	Adapter 90°	5/16" inv. flare QC x 1/4" utv. flare	33,00
VBHAA51	Adapter 90°	1/4" inv. flare QC x 5/16" utv. flare	35,00
VBHBV11	Kuleventil	1/4" inv. flare QC x 1/4" utv. flare	90,00
VBHBV15	Kuleventil	5/16" inv. flare QC x 1/4" utv. flare	95,00
VBHBV33	Kuleventil	3/8" inv. flare QC x 3/8" utv. flare	101,00
VBHSA15	Rett adapter	5/16" inv. flare QC x 1/4" utv. flare	28,00
VBHSA51	Rett adapter	1/4" inv. flare QC x 5/16" utv. flare	37,00
VB19102	Rett adapter	1/4" inv. flare QC x 3/8" utv. flare	120,00
VB19104	Rett adapter	3/8" inv. flare QC x 1/4" utv. flare	142,00
VBHCP1	Blendhette	1/4"	7,00
VBHCP5	Blendhette	5/16"	7,00
RCYA 121	Fyllenippel	1/4"	125,00
RCYA 125	Fyllenippel	5/16"	125,00

## 25. Koblinger og flaremutter



Kobling



Flaremutter



U40 Loddemuffe



Blendhette

Artikkelnummer	Beskrivelse	Dimensjon	Nøkkelvidde (mm)	Pris NOK/stk.
VB19144	Kobling 1/4"	1/4" x 1/4"	–	36,00
VB19145	Kobling 5/16"	5/16" x 5/16"	–	37,00
VB19146	Kobling 3/8"	3/8" x 3/8"	–	59,00
VB19140	Kobling 3/8"-1/2"	3/8" x 1/2"	–	66,00
VB19148	Kobling 1/2"	1/2" x 1/2"	–	84,00
VB19141	Kobling 1/2"-5/8"	1/2" x 5/8"	–	93,00
VB19150	Kobling 5/8"	5/8" x 5/8"	–	100,00
VB19151	Kobling 3/4"	3/4" x 3/4"	–	151,00
FL2	Flaremutter 1/4"	1/4"	17	8,00
FL3	Flaremutter 3/8"	3/8"	22	16,00
FL4	Flaremutter 1/2"	1/2"	26	26,00
FL43	Flaremutter 1/2"	For 3/8" rør	26	41,00
FL5	Flaremutter 5/8"	5/8"	29	61,00
FL6	Flaremutter 3/4"	3/4"	32	35,00
FLBC2	Blendhette 1/4"	–	–	3,00
FLBC3	Blendhette 3/8"	–	–	5,00
FLBC4	Blendhette 1/2"	–	–	7,00
VB19131	Nippelmutter	1/2 FFL x 3/8" MFL	–	148,00
U40-4	Loddemuffe	1/4 x 1/4	–	5,00
U40-6	Loddemuffe	3/8 x 3/8	–	10,00
U40-8	Loddemuffe	1/2 x 1/2	–	15,00
U40-10	Loddemuffe	5/8 x 5/8	–	20,00

## 26. Gass, kuldemedier og glykoler

2014  
2015



R-410A, 4 kg. Profi



N2, 5 og 10 kg med manometer



Nitrogen



R-410A, stål 10 kg

Type	Sylinder	Innhold	Særaggift/kg	Pris på forespørsel
R-410A	Profi	4,0 kg	569,25 NOK	–
R-410A	Stål	10,0 kg	569,25 NOK	–
R-134a	Stål	13,6 kg	429,00 NOK	–
R-404a	Stål	10,9 kg	1075,80 NOK	–
R-507	Stål	11,3 kg	1089,00 NOK	–
R-407C	Stål	11,3 kg	503,42 NOK	–
R-422A (R-22)	Stål	12,1 kg	835,66 NOK	–

Glykoler	Emballasje	Mengde	Leveringstid	Pris på forespørsel
Etylenglykol	Container	1000 kg	1 uke	–
Etylenglykol	Fat	200 kg	1 uke	–
Etylenglykol	Kanne	25 kg	1 uke	–
Propylenglykol	Container	1000 kg	1 uke	–
Propylenglykol	Fat	200 kg	1 uke	–
Propylenglykol	Kanne	25 kg	1 uke	–

Nitrogen	Sylinder	Innhold	Pris NOK
N2 sylinder	Stål 5 liter	5 og 10 kg	2600,00
N2	Fylling	5 og 10 kg	400,00/800,00
102233	Manometer	Se side 49	2600,00

## 27. Verneutstyr

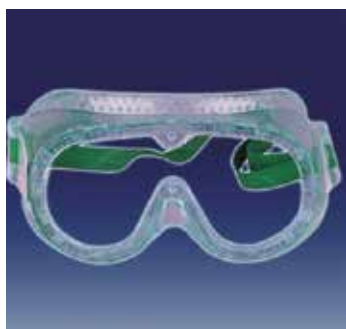

Vernebriller  
ikke ventilert



Vernebriller  
ventilert



Monteringshansker



Pakke med 100 stk gummi-  
hansker

Artikkel- nummer	Beskrivelse	Mengde	Beskrivelse	Nettopris NOK/stk.
VB 11002	Vernebriller	–	Ikke ventilert	110,00
VB 11003	Vernebriller	–	Ventilert	120,00
Hanske 01	Skinnhanske	par	Skinnhanske	63,00
Hanske 02	Nitrilhanske	100 stk	Sort monteringshanske i nitril	367,00



2014  
2015

# QsanTec



## Høyeste kvalitet til laveste pris!

Vi er spesialisert på utrustning og tilbehør for montering av split-aggregater. Vi lagerfører isolerte kobberrør, både enkeltrør og dobbeltrør. Vi har markedets bredeste sortiment av kanaler og kanaldeler for å skape en rask og delikat montering, både ute og inne.

### ENTRADE

Vi tåler sammenligning!

Entrade AS  
Semsveien 133, 1384 Asker  
Tel: 66 76 25 00. Fax: 66 76 25 01  
Mobil: 90 18 63 24 / 92 29 77 51  
E-post: morten@entrade.no  
E-post: vegard@entrade.no

[www.entrade.no](http://www.entrade.no)